



Multimedia Storage Viewer **P-6000**

# **User's Guide**

---

---

NPD3303-00 EN

---

# Contents

## ***Copyright and Trademarks***

---

## ***Safety Instructions***

---

Safety. . . . .	10
Warnings, Cautions, and Notes. . . . .	10
Important Safety Instructions. . . . .	10
Safety requirements. . . . .	16

## ***Chapter 1 Introduction***

---

Main Features. . . . .	18
Important Notice. . . . .	18

## ***Chapter 2 Getting Started***

---

Parts. . . . .	19
Front. . . . .	19
Back. . . . .	20
LCD and control panel. . . . .	21
Setting Up the Viewer. . . . .	22
Turning the power on. . . . .	22
Turning the power off. . . . .	23
Holding the key operations. . . . .	24
How to use the Home screen. . . . .	24
About the Software. . . . .	25
Installing the software. . . . .	26
Uninstalling the Software. . . . .	27

## ***Chapter 3 Transferring Data to the Viewer***

---

Transferring from CF/SD Memory Cards. . . . .	29
Supported types of memory cards. . . . .	29

Inserting CF/SD memory cards. . . . .	30
Removing a CF/SD memory cards. . . . .	30
Copying all data. . . . .	32
Copying particular data. . . . .	32
Transferring from USB Devices. . . . .	34
Connecting a USB device. . . . .	34
Copying all data. . . . .	35
Copying particular data. . . . .	35
Transferring from the Computer. . . . .	36

#### **Chapter 4 Transferring Data from the Viewer**

---

Transferring to USB Storage Devices or CF/SD Memory Cards. . . . .	37
Copying particular data. . . . .	37
Copying Data within Backup Files. . . . .	38
Transferring to the Computer. . . . .	39
Connecting the computer. . . . .	39
Copying via the Epson Link2 software. . . . .	40
Copying via the Explorer. . . . .	41
Disconnecting the viewer from the computer. . . . .	41

#### **Chapter 5 Viewing Images**

---

Viewing Photos and Videos. . . . .	43
Photo/Video file formats supported by the viewer. . . . .	43
Displaying photos or videos. . . . .	44
How to see the contents screen. . . . .	45
Displaying information. . . . .	47
Zooming a photo. . . . .	49
Rotating a photo. . . . .	49
Displaying photo enhance. . . . .	50
Playing back sound memo. . . . .	50
Playing videos. . . . .	50
Editing Photos. . . . .	51
Editing a photo. . . . .	51
RAW processing. . . . .	52
Managing Files and Folders. . . . .	52
Displaying photos as a slide show. . . . .	52

Setting folders as Private. . . . .	53
Changing a file's or folder's name. . . . .	54
Deleting files or folders. . . . .	55
Copying/Moving files or folders. . . . .	56
Protecting files or folders. . . . .	57
Setting Home screen wallpaper or folder icons. . . . .	58
Using ratings to filter your photos. . . . .	59
Setting the screen saver. . . . .	60
Monitoring the Color of Images. . . . .	60
About the Pop Up Menu. . . . .	61
For photo files. . . . .	62
For video files. . . . .	62

## **Chapter 6 *Creating Custom Print***

---

Preparing to Print. . . . .	64
Available types of paper. . . . .	64
Registering a watermark. . . . .	64
Using the Print Wizard Menu. . . . .	65
Creating Custom Print. . . . .	66
Selecting a photo. . . . .	66
Retouching a photo. . . . .	67
Cropping a photo. . . . .	69
Setting the layout. . . . .	70
Printing photos. . . . .	72
Making Copies of Custom Print. . . . .	74
Printing Original Photo. . . . .	74
Printing Contact Sheet. . . . .	75

## **Chapter 7 *Playing Music***

---

Transferring Audio Data from the Computer. . . . .	76
Audio file formats supported by the viewer. . . . .	76
Starting Playback. . . . .	77
Selecting the category. . . . .	77
Resume play. . . . .	78
Basic operations while playing music. . . . .	78
Repeat and Shuffle Play. . . . .	78

Using the Features for Music. . . . .	79
Audio equalizer setting. . . . .	79
Deleting album tracks from the viewer. . . . .	80
Creating a Playlist on the Viewer. . . . .	80
To add tracks to a created Playlist. . . . .	81
To delete a Playlist/remove tracks from a Playlist. . . . .	81
To change track order of a created Playlist. . . . .	82
About the Audio Pop Up Menu. . . . .	82

## **Chapter 8 Customizing Settings**

---

Changing the Viewer Settings. . . . .	83
---------------------------------------	----

## **Chapter 9 Viewing on a TV**

---

Using A/V Out. . . . .	86
------------------------	----

## **Chapter 10 Maintenance**

---

Cleaning the Viewer. . . . .	87
Preparing the Battery. . . . .	87
Installing the battery. . . . .	87
Charging the battery. . . . .	88
Removing the battery. . . . .	89

## **Chapter 11 Troubleshooting**

---

Error messages / Icons. . . . .	91
Power supply problems. . . . .	92
The power does not turn on. . . . .	92
The Charge lamp lights orange. . . . .	92
Viewing and playback problems. . . . .	92
Cannot access data. . . . .	92
The data is not displayed. . . . .	93
The color space information cannot be recognized. . . . .	93
The movie is not displayed clearly or stops abruptly. . . . .	93
Sound breaks off when the video or audio is played. . . . .	94

No sound comes out when a video is played. . . . .	94
Operation problems. . . . .	94
Cannot use the keys on the viewer. . . . .	94
Cannot access the existing folders. . . . .	94
Cannot copy. . . . .	95
Cannot delete. . . . .	95
Cannot increase the hard drive capacity of the viewer even if deleting files. . . . .	95
Cannot set/unset as a private folder. . . . .	95
Printing problems. . . . .	96
Cannot print. . . . .	96
The image color is different. . . . .	96
Resetting the Viewer. . . . .	96
Formatting Data in the Viewer. . . . .	97

## **Appendix A Customer Support**

---

Contacting Customer Support. . . . .	98
Before Contacting Epson. . . . .	98
Help for Users in North America. . . . .	98
Help for Users in Europe. . . . .	99
Help for Users in Australia. . . . .	99
Help for Users in Singapore. . . . .	100
Help for Users in Thailand. . . . .	101
Help for Users in Vietnam. . . . .	101
Help for Users in Indonesia. . . . .	101
Help for Users in Hong Kong. . . . .	103
Help for Users in Malaysia. . . . .	103
Help for Users in India. . . . .	104
Help for Users in the Philippines. . . . .	105

## **Appendix B Technical Specifications**

---

Standards and Approvals. . . . .	107
P-6000 (Model: G971A). . . . .	107
AC adapter (Model: A351H). . . . .	107
Battery (Model: D111A). . . . .	108
Specifications. . . . .	108
General. . . . .	108

Electrical..... 109  
Interface..... 110  
Battery..... 110  
AC adapter..... 110  
About Optional Accessories..... 111

***Index***

---

---

## Copyright and Trademarks

No part of this publication may be reproduced, stored in a retrieval system, or transmitted in any form or by any means, electronic, mechanical, photocopying, recording, or otherwise, without the prior written permission of Seiko Epson Corporation. The information contained herein is designed only for use with this Epson product. Epson is not responsible for any use of this information as applied to other products.

Neither Seiko Epson Corporation nor its affiliates shall be liable to the purchaser of this product or third parties for damages, losses, costs, or expenses incurred by the purchaser or third parties as a result of accident, misuse, or abuse of this product or unauthorized modifications, repairs, or alterations to this product, or (excluding the U.S.) failure to strictly comply with Seiko Epson Corporation's operating and maintenance instructions.

Seiko Epson Corporation shall not be liable for any damages or problems arising from the use of any options or any consumable products other than those designated as Original Epson Products or Epson Approved Products by Seiko Epson Corporation.

Seiko Epson Corporation shall not be held liable for any damage resulting from electromagnetic interference that occurs from the use of any interface cables other than those designated as Epson Approved Products by Seiko Epson Corporation.

EPSON® is a registered trademark of Seiko Epson Corporation.

Photo Fine and its logo are registered trademarks or trademarks of Seiko Epson Corporation in Japan and other countries. Photo Fine Premia is a proprietary technology of Epson Imaging Devices Corporation.

Microsoft®, Windows®, and Windows Vista® are registered trademarks of Microsoft Corporation in the United States and/or other countries.

Apple® and Macintosh® are registered trademarks of Apple Inc.

SD™ is a trademark.

QuickTime and the QuickTime logo are trademarks or registered trademarks of Apple Inc., used under license.

This product is licensed under the MPEG-4 Visual Patent Portfolio License for the personal and non-commercial use of a consumer for (i) encoding video in compliance with the MPEG-4 visual standard (MPEG-4 Video) and/or (ii) decoding MPEG-4 Video that was encoded by a consumer engaged in a personal and non-commercial activity and/or was obtained from a video provider licensed by MPEG LA to provide MPEG-4 Video. No license is granted or shall be implied for any other use. Additional information including that relating to promotional, internal and commercial uses and licensing may be obtained from MPEG LA, L.L.C. - see <[www.mpegla.com](http://www.mpegla.com)>

This product is licensed under the AVC Patent Portfolio License for the personal and non-commercial use of a consumer to (i) encode video in compliance with the AVC standard (AVC Video) and/or (ii) decode AVC Video that was encoded by a consumer engaged in a personal and non-commercial activity and/or was obtained from a video provider licensed to provide AVC Video. No license is granted or shall be implied for any other use. Additional information may be obtained from MPEG LA, L.L.C. - see <[www.mpegla.com](http://www.mpegla.com)>

MPEG Layer-3 audio coding technology is licensed from Fraunhofer IIS and Thomson.



Adobe<sup>®</sup>, Adobe<sup>®</sup> Photoshop<sup>®</sup>, and Adobe<sup>®</sup> RGB are registered trademarks of Adobe Systems Incorporated in the United States and/or other countries.

This product is protected by certain intellectual property rights of Microsoft. Use or distribution such technology outside of this product is prohibited without a license from Microsoft.

**General Notice:** *Other product names used herein are for identification purposes only and may be trademarks of their respective owners. Epson disclaims any and all rights in those marks.*

Copyright © 2008 Seiko Epson Corporation. All rights reserved.

---

## Safety Instructions

---

### Safety

Read all of these instructions before using the viewer, and keep this guide handy for later reference. Follow all warnings and instructions marked on the viewer and the accessories.

### Warnings, Cautions, and Notes



#### Warnings

*must be followed carefully to avoid bodily injury.*



#### Cautions

*must be observed to avoid damage to your equipment.*

#### Notes

*contain important information and useful tips on the operation of the viewer.*

### Important Safety Instructions

#### When using the viewer



#### Caution:

- Do not drop or apply any shock to the viewer. Take care when carrying it, as strong shocks may damage the internal hard disk drive and cause data to be lost.
- Epson is not responsible for backing up or recovering data. We recommend that you make your own backup files.
- Follow all warnings and instructions marked on this product.
- Use only AC adapter model A351H and Lithium-ion battery model D111A with this product.
- When connecting the viewer to a computer or other device with a cable, ensure the correct orientation of the connectors. Each connector has only one correct orientation. Inserting a connector in the wrong orientation may damage both devices connected by the cable.
- Do not insert objects into the slots or openings on the viewer.

- ❑ Do not touch the components inside the viewer unless instructed to do so in the user documentation. Never force the viewer's components into place. Although the viewer is designed to be sturdy, rough handling can damage it.
- ❑ Never spill liquid onto the viewer.
- ❑ If the viewer emits unusual noises, odors, or smoke, cancel the current operation and turn it off immediately. Remove the battery and disconnect the AC adapter from the viewer, then unplug the AC adapter from the power outlet and contact our customer support.
- ❑ Do not use your headphones for long periods at high volume as this can cause permanent hearing loss.  
Do not use your headphones while operating a vehicle or performing an activity that requires attention to external sound. When wearing your headphones, we strongly recommend setting the volume so that you can hear your normal speaking voice.
- ❑ Do not stand the viewer upright as it may fall over and be damaged.
- ❑ To prevent fire or electric shock, do not cover the viewer with a blanket or other covering that may give off a static electric shock.
- ❑ To prevent fire or electric shock, do not expose the viewer or its accessories to rain or moisture.
- ❑ To prevent fire or explosion, do not use the viewer where flammable or volatile gas is stored.
- ❑ Do not use the viewer outdoors during a thunderstorm.
- ❑ Do not use the viewer after moving it between extreme temperatures, which may cause condensation to form on electronic parts.
- ❑ If you use the viewer in places where the use of electronic devices is limited, such as in airplanes or hospitals, follow all instructions in those places.

### **When using the battery**



#### **Caution:**

- ❑ *There is a risk of explosion if the battery is replaced by the incorrect type. Use the specified new batteries only. Dispose of used batteries according to the instructions.*
  - ❑ *If charging is not complete after 11 hours or more (when charging with the main unit while the power is off), stop charging. If you notice any problems during charging such as a high temperature or bad smell, stop charging immediately.*
- ❑ If battery acid gets into your eyes or on your skin, immediately rinse the affected area thoroughly with water and seek medical treatment. If a battery is swallowed, seek medical treatment immediately.

- Use only an Epson Lithium-ion battery for the viewer according to the directions in the user documentation.
- You can use the following two methods to charge the battery. Connect the viewer (Model: G971A/G971B) and the AC adapter (Model: A351H). Place the battery in the battery charger (Model: EU-217).
- Do not use the battery that comes with the viewer for other devices.
- To protect against short-circuiting, do not remove the outside case of the battery.
- Do not handle the battery with wet hands or use them near water.
- Do not expose the battery to water or high humidity.
- Do not drop, puncture, disassemble, mutilate, or short-circuit the battery.
- Do not place the battery near or into fire or water.
- Do not use batteries that are leaking or damaged in any way.
- Do not charge the battery using devices except for this product or the specified battery charger (Model: EU-217).
- Do not use, charge, or leave the battery near an open flame or in a very hot location with a temperature of 35°C or above.
- Keep batteries away from heat sources.
- Do not leave the battery in a vehicle, to prevent the battery from overheating.
- Do not insert objects into any openings as they may touch dangerous voltage points or short-circuit components.
- Prevent the battery from coming into contact with metal objects that could short-circuit it, such as coins or keys.
- Do not insert the battery into power outlets or other power sources such as car cigarette lighter sockets.
- Do not solder wires or terminals directly to the battery.
- Do not touch battery terminals.
- Keep batteries away from open flame if they leak or smell strange.
- If overheating, discoloration, or distortion occurs, remove the battery from the viewer and do not use it.

- Charge the battery before using it if it has not been used for a long period.

### **When storing the batteries**

- When not using the viewer for a long period, remove the batteries from the viewer and store them separately.
- Do not store batteries where the temperature or humidity is very high.
- Store batteries out of children's reach.

### **When disposing of the batteries**

Before disposing of batteries, make sure you discharge them completely.



#### **Warning:**

- Be sure to securely cover the each end of the battery with tape to prevent combustion or explosion when disposing.*
- Do not dispose of batteries as ordinary refuse. Instead, dispose of them in a collection or recycle box in accordance with local laws.*
- Do not incinerate or dispose of the battery in fire.*

*For European users:*



Do not dispose of batteries with ordinary refuse. Instead, dispose of them in a recycle box in accordance with local laws.

*For users in the United States and Canada:*



This mark indicates that the battery will be recycled by RBRC. When you dispose of the battery, contact RBRC.

### **When using the AC adapter**

- Use only the type of power source indicated on the AC adapter's label, and always supply power directly from a standard, domestic power outlet with a power cord that meets the relevant local safety standards. If you are not sure of the power supply specifications in your area, contact your local power company or contact our customer support.

- ❑ Place the AC adapter near an electrical outlet where the power cord can be easily unplugged.
- ❑ The AC adapter and power cable provided are designed for use with the viewer. Do not attempt to use them with other electronic devices unless specified.
- ❑ Do not remove the AC adapter from the viewer during operations (connecting the AC adapter during operations is possible).
- ❑ The AC adapter included is designed for use with the viewer. Use of any other adapter could result in fire, electrical shock, or injury.
- ❑ Use only AC adapter model A351H with the viewer.
- ❑ Make sure the total amperage of all devices plugged into the power outlet does not exceed the power outlet's ampere rating.
- ❑ Do not connect the AC adapter when the battery is not installed. Otherwise, the viewer may be damaged.
- ❑ If you plan to use this product in Germany, the building installation must be protected by a 16 amp circuit breaker to provide adequate short-circuit protection and over-current protection for this product.
- ❑ Do not use a damaged or frayed AC adapter.
- ❑ If you use an extension cord with the viewer, make sure the total amperage of all devices plugged into the extension cord does not exceed the cord's amperage rating.
- ❑ Never disassemble, modify, or attempt to repair the AC adapter by yourself except as specifically explained in this guide.
- ❑ Do not use power outlets controlled by wall switches or automatic timers.
- ❑ Do not use power outlets on the same circuit as large motors or other appliances that may cause voltage fluctuations.
- ❑ Avoid using outlets on the same circuit as photocopiers or air control systems that regularly switch on and off.
- ❑ To prevent fire or electric shock, do not cover the AC adapter with a blanket or similar covering.
- ❑ Position the viewer's power cable so that it will not be stepped on or run over.
- ❑ Do not place any objects on the power cable and the AC adapter.
- ❑ Keep the power cable straight at the ends and at the points where it enters the transformer.

- ❑ The power cable should be placed so as to avoid abrasions, cuts, fraying, crimping, kinking, and other damage.
- ❑ If the AC plug does not fit your outlet, have a proper outlet installed by a qualified electrician.
- ❑ Remove the AC plug from the outlet during lightning storms.

*For US and Canadian users:*

Use the included power cord or a 6 to 10 foot UL-approved type SPT-2 or heavier type, 2 □ 18 AWG cord with a 125 V 10 A plug and 125 V 7 A connector.

***When using a memory card***

- ❑ Only memory cards designed for the viewer's specifications can be used.
- ❑ Do not remove a memory card or turn off the viewer while the **Access** lamp is flashing. See "Parts" on page 19 to find where the **Access** lamp is.

***When using the LCD***

- ❑ The LCD panel on the viewer may contain a few small bright or dark spots. These are normal and do not mean that your LCD panel is damaged in any way.
- ❑ If the LCD panel on the viewer is damaged, consult your dealer.
- ❑ If the liquid crystal solution contained in the LCD panel on the viewer leaks out and gets onto your hands, wash them thoroughly with soap and water. If it gets into your eyes, flush them immediately with water. If discomfort or vision problems remain after a thorough flushing, see a doctor immediately.
- ❑ Only use a soft, dry cloth to clean the display. Do not use liquid or chemical cleaners.

***When storing, maintaining, or transporting the viewer***

- ❑ Do not store the viewer outdoors.
- ❑ Do not store the viewer near water.
- ❑ Do not store the viewer in a location subject to high temperature or humidity.
- ❑ Do not store the viewer in a location subject to rapid changes in temperature or humidity.
- ❑ Do not store the viewer in a location subject to direct sunlight or strong light sources.

- ❑ Unplug the viewer from the power outlet before cleaning it. Use a damp cloth for cleaning and do not use liquid or aerosol cleaners.
- ❑ Remove the battery from and unplug the viewer and refer servicing to qualified service personnel under the following conditions: The power cable or plug is damaged; liquid has entered the viewer or its accessories; the viewer or its accessories have been dropped or the case is damaged; the viewer or its accessories do not operate normally or exhibit a distinct change in performance.

### **Safety information for United Kingdom users**

The following safety information applies to the AC adapter.



**Warning:**

*Refer to the rating plate for the voltage and check that the appliance voltage corresponds to the supply voltage.*

**Important:**

*The wires in the mains lead fitted to this appliance are colored in accordance with the following code:*

*Blue — Neutral*

*Brown — Live*

*As the colours of the wires in the mains lead of this appliance may not correspond with the coloured markings identifying the terminals in your plug, proceed as follows;*

*The blue wire must be connected to the terminal in the plug marked with the letter N.*

*The brown wire must be connected to the terminal in the plug marked with the letter L.*

*If damage occurs to the plug, replace the lead set or consult a qualified electrician.*

### **For United Kingdom, Hong Kong, and Singapore users**

Replace fuses only with fuses of the correct size and rating.

### **Safety requirements**

Main plug	Use a 3-pin or a 2-pin main plug that is registered with the Safety Authority.
Flexible cord	Use a double insulated flexible cord that is certified* to the relevant IEC or BS standards.



Appliance connector	Use an appliance connector certified* to the relevant IEC or BS standards.
---------------------	--

\*Certified by member of IECEE CB Scheme.

## Chapter 1

### Introduction

---

#### Main Features

With the viewer, you can easily save, view, and print images you have taken with a digital camera. You can also play videos and music. The main features are described below.

- Photo Fine Premia is a high-resolution, wide color gamut (Adobe RGB) liquid crystal display with a wide viewing angle. You can view images easily in high resolution anywhere, anytime without a computer or other special device.
- You can play videos and music easily anywhere, anytime without a computer or other special device.
- You can print images directly with PictBridge enabled printers.
- You can save photo, video, and audio data in the viewer.

---

#### Important Notice

The viewer uses the hard disk as its storage medium. Although designed to be resistant against mechanical and electromagnetic shock, because of the hard disk's characteristics, there is a danger that data may be lost or the service life of the viewer may be adversely affected due to malfunction caused by these factors. Make sure to handle the viewer in which your valuable image data is stored with care, and store backup copies to your computer whenever possible.



**Caution:**

- Do not expose the viewer to any impact, doing so may cause malfunctions.*
- Do NOT format the viewer's hard disk drive from your computer, as this will render the viewer inoperable. If this happens, test the format by following the procedure in "Formatting Data in the Viewer" on page 97. If this does not fix the problem, you should contact an authorized Epson service center. Repairs will be chargeable and are not covered by Epson's warranties.*

## Chapter 2

# Getting Started

## Parts

### Front

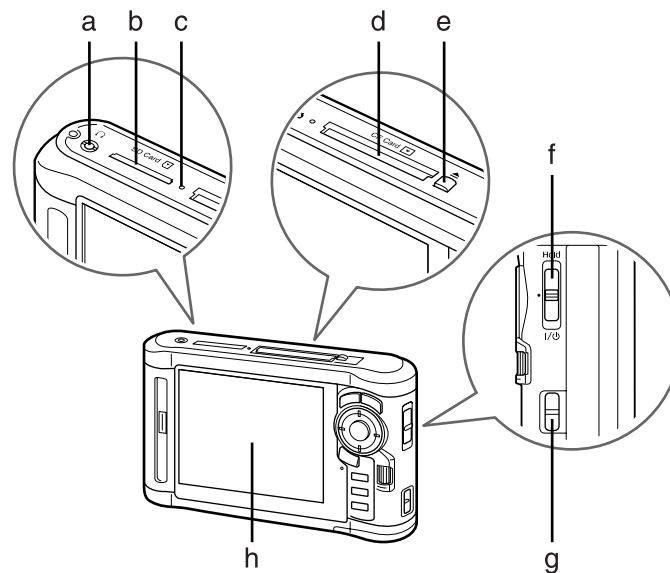

- a. Headphones connector
- b. SD Card slot
- c. Access lamp
- d. CF Card slot
- e. CF Card eject button
- f. Power switch with Hold function
- g. Strap hook
- h. Liquid Crystal Display (LCD)

## Back

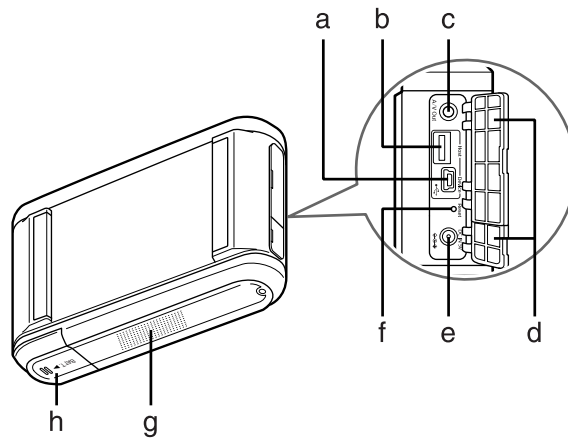

- a. USB connector (slave)
- b. USB connector (host)
- c. A/V Out connector
- d. Cover
- e. AC adapter connector
- f. Reset button
- g. Speaker
- h. Battery cover

## LCD and control panel

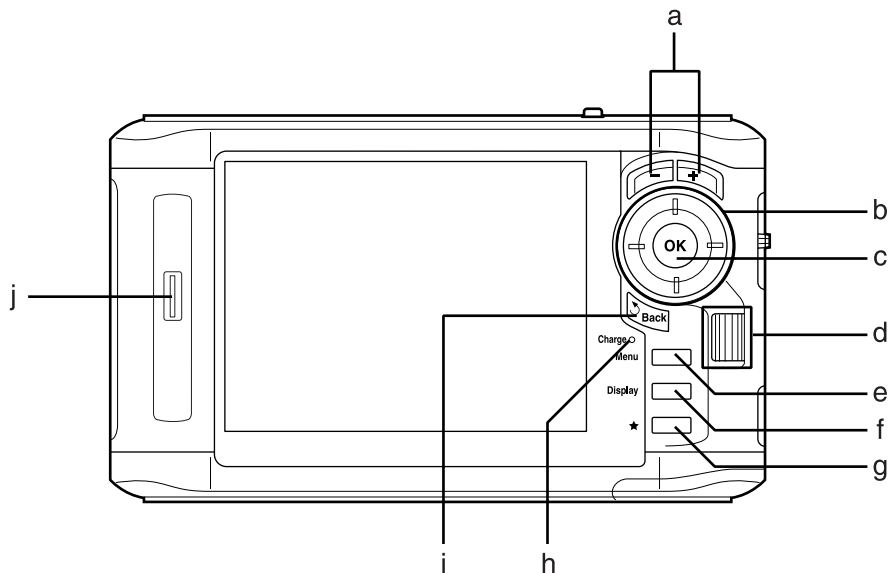

a	-/+ key	Press to zoom a photo, and adjust the volume.
b	4-way ring (Up/ Down/Left/Right key)	Press to move the cursor or highlight. You can select an item by pressing this key to the up, down, left, or right.
c	OK key	Press to complete the selection and proceed to the next step.
d	Wheel key	Roll to move the cursor or highlight. You can select items quickly by rolling this key. This operates in a similar way to the <b>Up</b> , <b>Down</b> , <b>Left</b> , and <b>Right</b> keys.
e	Menu key	Press to display the pop up menu.
f	Display key	Press to switch the screen mode.
g	★ key	Press to rate a particular photo and determine the selection. For details, see "Using ratings to filter your photos" on page 59.
h	Charge lamp	Lit green during battery charging. Lit orange when a battery error has occurred.
i	Back key	Press to cancel the selection and return to the previous screen.
j	Illumination lamp (Blue)	Flashes during operations such as turning the power on, printing, LCD power-off mode, and so on.

## Setting Up the Viewer

This section describes how to turn the power on/off and use the Home screen, and so on.

### Turning the power on

Slide the power switch to **I/O** as shown below. The power switch will return to the original position.

The **Illumination** lamp turns on.

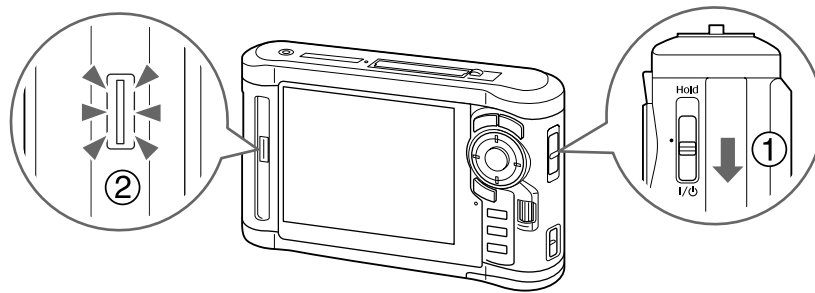

When you turn on the viewer for the first time, the Language screen and Date and Time screen are displayed. Follow the instructions below.

1. The Language screen appears. Select the language to use with the **Up** or **Down** key, and press the **OK** key.

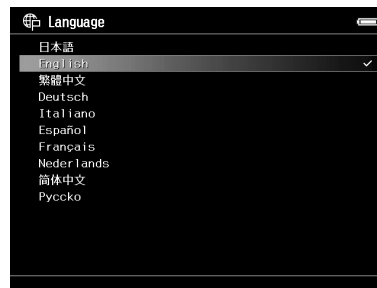

2. After the message saying “Set current Date and Time.” appears, press the **OK** key to proceed.

- Set the date and time using the **4-way ring**.

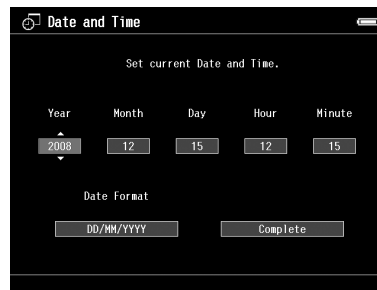

- After you finish all settings, select **Complete** using the **Right** or **Left** key, then press the **OK** key.

**Note:**

- If approximately 24 hours passes after removing the battery, the date and time settings may be lost, and will need to be set again.
- If the date and time settings are erased, the Date and Time screen is displayed when you turn on the viewer next time.
- After changing the battery, make sure that the date and time is set correctly. If necessary, set the date and time again.
- You can change the settings later. For details, see "Changing the Viewer Settings" on page 83.

## Turning the power off

- Make sure that the **Access** lamp is off.
- Slide the power switch to **I/O** as shown below and hold it down for several seconds until the shut down display appears. The power switch will return to the original position.

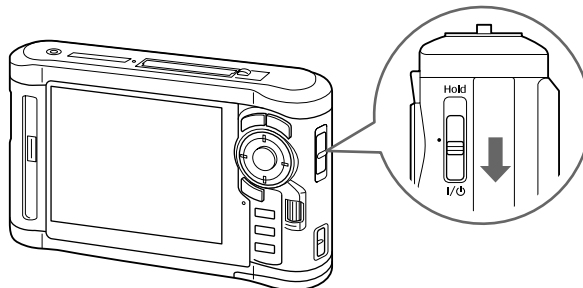

## Holding the key operations

You can deactivate the keys temporarily by sliding the power switch to **Hold** as shown below.

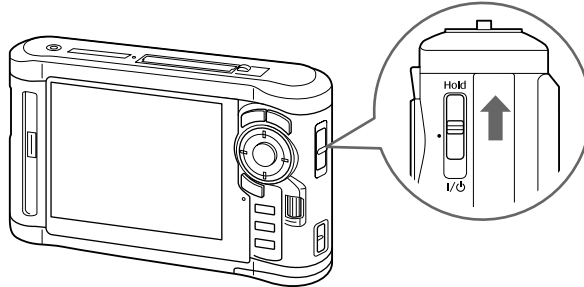

### Note:





- ❑ To release **Hold**, slide the power switch back to the middle.
- ❑ Putting the key operations on hold is a useful function when carrying the viewer in your bag while listening to music with the headphones.

## How to use the Home screen



When turning on the viewer, the Home screen appears first. All operations can be started from this screen.



### Icons

	<p>Indicates the remaining charge in the battery.</p> <ul style="list-style-type: none"> <li> : Indicates sufficient battery power.</li> <li> : Indicates moderate battery power.</li> <li> : Indicates low battery power.</li> <li> : Indicates the viewer is charging.</li> </ul>
---	---



	Indicates the CF memory card is set.
	Indicates the SD memory card is set.
	Indicates the key operations are on hold. For details, see "Holding the key operations" on page 24.

## Menu items

<b>Backup Files</b>	Select to display files/folders backed up from CF/SD memory cards and a USB device.
<b>My Photos</b>	Select to display files/folders stored in the Photos folder.
<b>My Videos</b>	Select to display files/folders stored in the Videos folder.
<b>My Music</b>	Select to listen to music transferred from the computer. For details, see "Playing Music" on page 76.
<b>Memory Card</b>	Select to display files on CF/SD memory cards or store memory card data onto the viewer.
<b>USB Device</b>	Select to transfer data between a USB device and the viewer or to use the USB Display Plug-In.
<b>Settings</b>	Select to set the viewer's various settings.
<b>Print Wizard</b>	Select to follow procedures to complete work on your photos and print. You can edit, crop, layout, and print your photos. For details, see "Creating Custom Print" on page 64.

## About the Software

The viewer uses the following specified software.

Epson Link2	You can transfer data from the computer to the viewer easily.
USB Display Plug-In	You can display images from Adobe Photoshop products on the viewer and edit photos while confirming a faithful color representation.
Quick Time	

## Installing the software

You are required to install the data in the viewer. Connect the viewer to the computer, then install the necessary software. For details about computer connection, see "Connecting the computer" on page 39.

**Note:**

- Do not delete the installer (EXE/DMG file) in the viewer's hard disk.
- It is recommended to back up the installer onto the computer.
- You need administrative privileges to install the software.

### For Windows users

1. Connect the viewer to the computer.
2. Click **Start**, select **My Computer** (or **Computer**), then double-click the viewer's hard disk drive icon.
3. Copy the P\_XXXX\_WIN\_SOFTWARE icon to your computer.

**Note:**

*P\_XXXX is the model name of your viewer.*

4. Double-click the **P\_XXXX\_WIN\_SOFTWARE** icon.
5. Select **Desktop** to decompress the files onto, then click **Yes**.

**Note:**

*For Windows Vista, when the User Account Control window appears, click **Continue**.*

6. On the software installation screen, click **Easy Install**.

**Note:**

*If you are prompted to select a language, select your preferred language.*

7. When the software license agreement screen appears, read the statement and then click **Agree**.
8. Select your country, then follow the on-screen instructions.

9. When a message appears indicating that installation is complete, click **Exit** or **Restart Now**.

**Note:**

When **Restart Now** appears, click the button to restart your computer.

### **For Macintosh users**

1. Connect the viewer to the computer.
2. Double-click the viewer's hard disk icon on the desktop.
3. Copy P\_XXXX\_MAC\_SOFTWARE.DMG to your computer.

**Note:**

P\_XXXX is your viewer's model name.

4. Double-click **P\_XXXX\_MAC\_SOFTWARE.DMG**.
5. Double-click the **Mac OS X** icon.
6. On the software installation screen, click **Easy Install**.

**Note:**

If you are prompted to select a language, select your preferred language.

7. When the software license agreement screen appears, read the statement and then click **Agree**.
8. Select your country, then follow the on-screen instructions.
9. When a message appears indicating that installation is complete, click **Exit** or **Restart Now**.

**Note:**

When **Restart Now** appears, click the button to restart your computer.

### **Uninstalling the Software**

To uninstall the software, follow the procedure below. Be sure to back up any viewer installation data before deleting.

### **For Windows users**

1. Quit all applications.
2. For Windows Vista, click  **Start**, then click **Control Panel**.  
For Windows XP, click **Start**, click **Control Panel**, then click **Add or Remove Programs**.  
For Windows 2000, click **Start**, point to **Settings**, then click **Control Panel**.
3. For Windows Vista, double-click the **Programs and Features** icon.  
For Windows XP, click the **Change or Remove Programs** icon.  
For Windows 2000, double-click the **Add/Remove Programs** icon.
4. Select the software, and then follow the on-screen instructions.

**Note:**

*After a message saying "Your computer needs to be restarted." appears, click **Restart Now** to restart your computer.*

### **For Macintosh users**

1. Select **Custom Install** in step 4 of "For Macintosh users" on page 27.
2. Select **Epson Link2** or **USB Display Plug-In**.
3. On the software installation screen, select **Uninstall**.

**Note:**

*After a message saying "Your computer needs to be restarted." appears, click **Restart Now** to restart your computer.*

## Chapter 3

### Transferring Data to the Viewer

---

Transferring the data of a full memory card or other USB devices to the viewer makes it possible for you to continue taking pictures.

---

#### Transferring from CF/SD Memory Cards

The viewer has a CF Card slot and an SD Card slot.

You can copy the data from CF/SD memory cards onto **Backup Files**.



**Caution:**

- To use a memory card correctly, read the manuals provided with the memory card.
- Never remove a memory card while the **Access** lamp is flashing. Doing so may cause data in the card or HDD to be lost or damaged.
- Do not put stickers on memory cards. The sticker may peel off, preventing the card from being ejected and damaging the viewer.
- Avoid using or storing the card in direct sunlight, or in places that are extremely hot, humid, or dusty.

**Note:**

- Before copying data, charge the battery fully. If the battery is low, connect the AC adapter. The transfer is canceled if the viewer's power supply is disconnected during transfer.
- 1 GB of data may take approximately 2 minutes or more to copy, depending on the memory card you use.

#### Supported types of memory cards

- CF (CompactFlash) memory card (Type2 and 3.3 V, including Micro Drive)
- SD memory card, SD High-Capacity card
- MultiMedia Card, MultiMedia Card Plus

**Note:**

Commercially available adapters will be required to use other memory cards (miniSD, microSD, RS-MMC, Memory Stick Duo, Memory Stick PRO Duo, xD-Picture Card, and so on). Contact our customer support for details.

## Inserting CF/SD memory cards

Insert a compatible memory card in the CF card slot or the SD card slot.

Insert the memory card into the memory card slot with the label side facing the display side of the viewer, then push it fully into the slot.

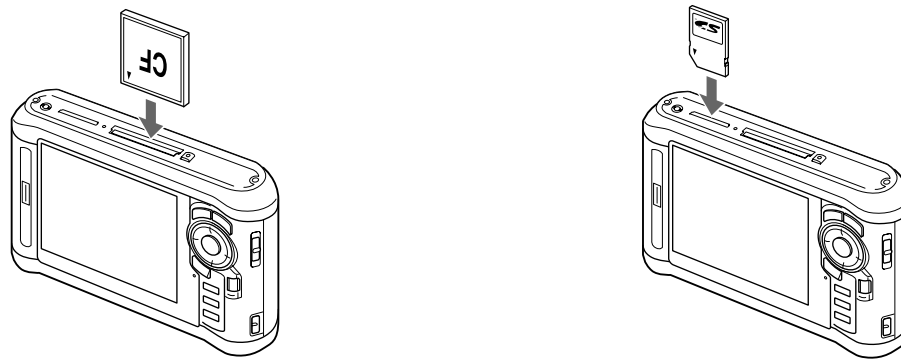
**Note:**

Insert memory cards in the correct direction. Otherwise, the memory card and the viewer may be damaged.

## Removing a CF/SD memory cards

1. Make sure that the **Access** lamp is off.

**Caution:**

Never remove a memory card while the **Access** lamp flashes. Doing so may cause data in the card to be lost or damaged.

- For a CF memory card, push the eject button twice. The memory card is pushed out.

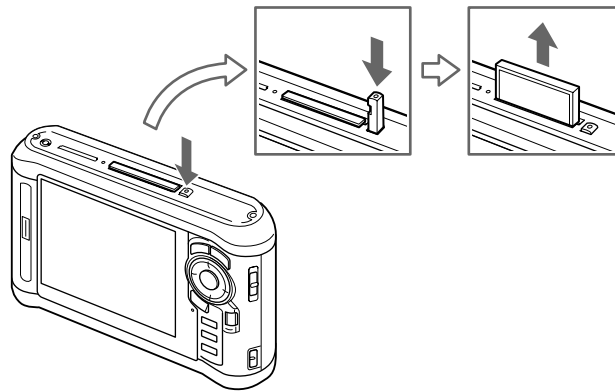

For an SD memory card, push the memory card down slightly. The memory card is ejected.

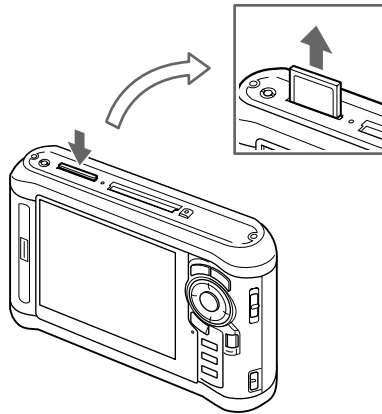

- Pull out the memory card.

**Note:**

- When using a memory card set in the CF adapter, do not remove only the memory card. Disconnect the CF adapter from the viewer.
- Be sure to use the viewer with the eject button pushed in to avoid possible damage.

## Copying all data

1. Insert a CF/SD memory card.

**Note:**

*According to the screen that appears when inserting the memory card, skip step 2.*

2. Select **Memory Card** in the Home screen using the **Up** or **Down** key, then press the **OK** key.
3. In the Memory Card screen, select **CF Memory Card Backup** or **SD Memory Card Backup** using the **Up** or **Down** key.
4. Press the **OK** key to start copying.

The message saying “Backing up memory card files..” appears. After a message appears indicating that backup is complete, the backup data is displayed automatically.

**Note:**

*When backing up memory card data to the viewer, you can make settings to only transfer data that has not been previously backed up, and to automatically delete data in the memory card after the backup is complete. From the Home screen, select **Settings - Backup Settings**. For details, see “Changing the Viewer Settings” on page 83. Differential data backup is not available if the SD memory card is locked.*

## Checking the copied data on the viewer

1. Select **Backup Files** in the Home screen using the **Up** or **Down** key, then press the **Right** key.
2. Select and check the folder named according to the year and date (when the data is copied), and the sequential number (e.g.: “19092008D.XXX”).

**Note:**

*You can change the date format. Select **Settings** in the Home screen, then select **Date and Time**.*

## Copying particular data

1. Follow steps 1 and 2 of “Copying all data” on page 32.
2. In the Memory Card screen, select **Browse CF Memory Card** or **Browse SD Memory Card** using the **Up** or **Down** key.



3. Press the **OK** key to show the data on the memory card.

**Note:**

*If you are copying or moving only one file, use the **4-way ring** to select the target file.*

4. Press the **Menu** key to display the pop up menu, select **Copy/Move** using the **Up** or **Down** key, then press the **OK** key.
5. Select **Select and Copy Files** using the **Up** or **Down** key, then press the **OK** key.

**Note:**

*When selecting only one file to copy, select **Copy this File**.*

6. Use the **4-way ring** and the **★** key to enter check marks in the check boxes of files or folders to back up, then press the **OK** key to complete.

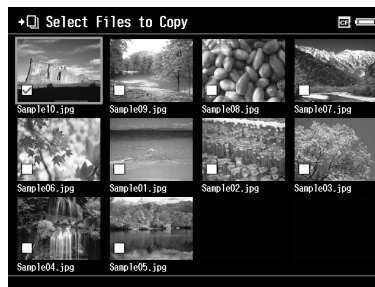

**Note:**

*Pressing the **Menu** key in the thumbnails screen displays the pop up menu. You can select either **Select All** or **Deselect All**, then press the **OK** key, or select **Apply** from the pop up menu.*

7. Use the **4-way ring** to select the target folder, then press the **OK** key.
8. Check the copied data following the steps in "Checking the copied data on the viewer" on page 32.

---

## Transferring from USB Devices

You can copy data from USB devices directly using the USB Standard-A connector of the viewer. Only a USB device supporting the USB Mass Storage specification can be used. You can use the following USB storage devices capable of copying: digital cameras, external HDD drives, USB memories, and card reader/writers. You can also use the following Epson Multimedia Storage Viewers: P-2000, P-4000, P-2500, P-4500, P-3000, P-5000, P-6000, and P-7000.

### Connecting a USB device

1. Connect the AC adapter to the viewer if possible.

**Note:**

*Some USB devices require the viewer to be powered via the AC adapter.*

2. Connect the viewer and the USB device. Open the side upper cover and connect a USB cable to the Host (Standard-A) connector and the other end to the USB device, or connect a USB memory to the viewer.
3. Turn on the viewer and the USB device.

**Note:**

- If the USB device has a supplied AC power cord, plug it in also, to prevent data loss while transferring.*
- Using a USB hub is not supported.*
- A USB device without power may not be activated.*
- A USB device with the certification or encryption function cannot be used.*
- When you connect a USB device to this viewer, use the USB cable supplied with the device.*
- Do not connect USB interfaces (Host-standard A and Slave-Mini B) at the same time. It may cause a malfunction.*
- Do not touch the Slave-Mini B connector during the USB data transfer.*
- Some USB devices may not be compatible.*

## Copying all data

When a USB device, such as a digital camera, containing a DCIM folder is connected, you can copy all of the data to the viewer. You cannot copy all of the data from a USB device that does not contain a DCIM folder in the root folder.

1. Select **USB Device** on the Home screen using the **Up** or **Down** key, then press the **OK** key.
2. Select **Connect to USB device** using the **Up** or **Down** key, then press the **OK** key.
3. Select **Backup USB device to Viewer** using the **Up** or **Down** key, then press the **OK** key.



### Note:

- ❑ When backing up USB device data to the viewer, you can make settings to only transfer data that has not been previously backed up, and to automatically delete data in the USB device after the backup is complete. From the Home screen, select **Setting - Backup Settings**. For details, see "Changing the Viewer Settings" on page 83.
- ❑ 1 GB of data may take approximately 3 minutes or more to copy, depending on the USB device you use.

## Checking the copied data on the viewer

Follow steps 1 and 2 of "Checking the copied data on the viewer" on page 32.

## Copying particular data

When you want to copy specific data from a digital camera or from a USB device that does not contain a DCIM folder, you can copy data to the viewer by following the procedure below.

1. Select **USB Device** on the Home screen using the **Up** or **Down** key, then press the **OK** key.

2. Select **Connect to USB device** using the **Up** or **Down** key, then press the **OK** key.
3. Select **Browse USB device** using the **Up** or **Down** key.



4. Press the **OK** key to display the data stored on the USB device.
5. Follow steps 4 to 7 in "Copying particular data" on page 32.

---

## ***Transferring from the Computer***

When the viewer is connected to a computer, the viewer is recognized as an external hard disk. You can transfer data from the computer using the included software or your operating system's file management software such as Explorer or Finder.

For details, see "Transferring to the Computer" on page 39.

## Chapter 4

---

### **Transferring Data from the Viewer**

You can transfer data in the viewer to a USB device or computer and save important data.

---

#### **Transferring to USB Storage Devices or CF/SD Memory Cards**

You can transfer the data of this viewer to USB devices or memory cards. This is useful when you want to back up data in the viewer without using a computer. However, both the viewer and the USB device will require a power supply, and may take some time to transfer the data depending on the volume of data in the viewer. You can use the following USB storage devices capable of copying: external HDD drives, CD/DVD drives, USB memories, and card reader/writers.

Note the following points when burning data to a CD/DVD.

- Insert a disc before connecting the CD/DVD drive to the viewer.
- Use only blank media.
- After copying, you cannot add any more data to the media.
- You can only record on single-layer DVD-R discs.
- Some CD/DVD drives may not be compatible.
- Place data to transfer in a viewer folder with a hierarchy of no more than six levels.

#### **Copying particular data**

**Note:**

*This function is not available if the SD memory card is locked.*

1. Connect a USB device or insert a memory card. For details, see "Connecting a USB device" on page 34 or "Inserting CF/SD memory cards" on page 30.
2. Highlight a file or folder to copy.
3. Press the **Menu** key to display the pop up menu, select **Copy/Move** using the **Up** or **Down** key, then press the **OK** key.

4. Select **Select and Copy Files** using the **Up** or **Down** key, then press the **OK** key.

**Note:**

When selecting only one file to copy, select **Copy this File**. When moving files, select **Move this File** or **Select and Move Files**.

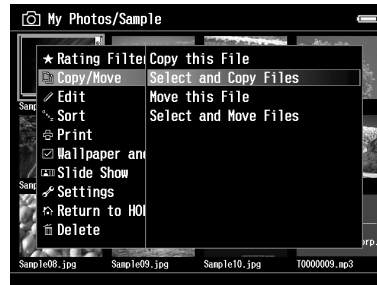

5. Use the **4-way ring** and the **★** key to enter checkmarks in the check boxes of files or folders to back up, then press the **OK** key to complete.
6. Select **USB Device**, **CF Memory Card**, or **SD Memory Card** using the **Up** or **Down** key, then press the **OK** key.

**Note:**

- Pressing the **Menu** key in the thumbnails screen displays the pop up menu. You can select either **Select All** or **Deselect All**, then press the **OK** key, or select **Apply** from the pop up menu.
- When the viewer is connected to a USB device, do not connect a computer or printer to the Slave-Mini B, or touch the connector interface.

## Copying Data within Backup Files

**Note:**

- This function is only available for USB devices.
- Data in the viewer's Backup Files can be copied to a HDD drive or a CD/DVD drive according to the date the folders were created. Only folders that were not copied previously are identified and copied.  
When copying folders to a CD/DVD drive according to date, it cannot perform incremental copying.

1. Connect the USB device. For details, see "Connecting a USB device" on page 34.
2. Select **USB Device** in the Home screen using the **Up** or **Down** key, then press the **OK** key.

3. Select **Connect to USB Devices** using the **Up** or **Down** key, then press the **OK** key.
4. Select **Copy all Backup Files** using the **Up** or **Down** key, then press the **OK** key.



The data is copied as folders in Backup Files.

**Note:**

*You can copy only additional folders as those which have already been copied are not copied again.*

---

## **Transferring to the Computer**

### **Connecting the computer**

If you connect the viewer to the computer, the viewer is recognized as an external HDD. Before transferring, install the software. For details, see "Installing the software" on page 26.

1. Connect the AC adapter.
2. Turn on the viewer and the computer.

3. Open the USB connector's cover and connect the USB cable to the viewer. Then connect the other end of the USB cable to the computer.

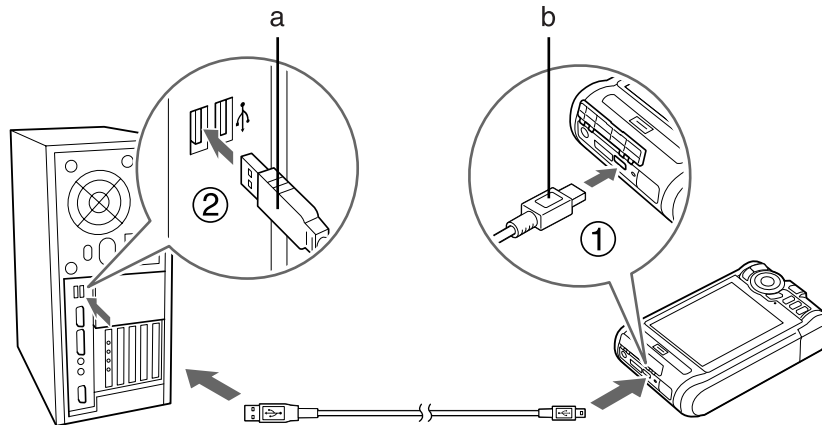

- a. USB (Standard-A)
- b. USB (Mini-B)

4. Press the ★ key on the Home screen.

**Note:**

You can also connect by selecting **USB Device**.

5. When the connection to the computer is complete, the LCD display turns off.

**Note:**

- Disconnect the USB cable from the viewer when not operating with a computer or printer.
- When the viewer is connected to a computer, do not connect a USB device to the Host-standard A, or touch the connector interface.

## Copying via the Epson Link2 software

### For Windows

Click **Start**, point to **All Programs** (or **Programs**), then select **EPSON**. Select **Epson Link2**, then click **Epson Link2**.

Alternatively, click the shortcut icon of the Epson Link2 software on the desktop.



Only data that has not yet been backed up will be copied to the computer automatically. For details, see the online Epson Link2 User's Guide.

### **For Macintosh**

Double-click the **Epson Link2** icon in the Epson Link2 folder.

Only data that has not yet been backed up will be copied to the computer automatically. For details, see the online Epson Link2 User's Guide.

### **Copying via the Explorer**

You can copy and move files that are compatible with your computer's Explorer. When browsing the viewer's HDD on a computer, BACKUP, MUSIC, PHOTOS, and VIDEOS correspond to **Backup Files**, **My Music**, **My Photos**, and **My Videos** in the viewer.

**Note:**

*Do not change the folder name. If changed, a new, empty folder will be created in the original name, and you will need to move data to the new folder.*

### **Disconnecting the viewer from the computer**

#### **For Windows**

1. Click **Unplug or Eject Hardware** on the computer screen.

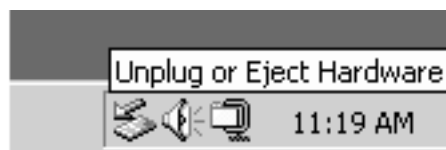

**Note:**

*The message and the icon differ depending on the Windows version.*

2. Disconnect the USB cable from the computer.
3. Disconnect the USB cable from the viewer.

***For Macintosh***

1. Drag and drop the viewer icon and memory cards (if inserted) to the trash can on the computer screen.
2. Disconnect the USB cable from the computer.
3. Disconnect the USB cable from the viewer.

## Chapter 5

### Viewing Images

#### Viewing Photos and Videos

#### Photo/Video file formats supported by the viewer

##### Photo

Supported Files	Extension	Details
JPEG*	.jpg .jpeg	Minimum size: 320×240 pixels Maximum size: 31 megapixels Maximum image aspect ratio: 3:1
RAW**	.erf .nef .crw .cr2 .mrw .pef .orf .raf .arw .DNG***	JPEG data stored in the header of RAW files are displayed.

\*The progressive JPEG format is not supported.

\*\*The viewer supports images in RAW format taken with most digital cameras produced by Nikon, Canon, KONICAMINOLTA, PENTAX, Olympus, FUJIFILM, SONY, and Epson. Contact our customer support for details.

\*\*\*The viewer supports only the JPEG preview embedded DNG format.

**Note:**

*TIFF is not supported.*

## Video

File Format	Video Codec	Audio Codec	Detail
AVI	MPEG4 (Advanced Simple Profile)	AAC, G.711 (uLaw, ALaw), PCM, ADPCM (G.726, MS IMA ADPCM)	30 fps: 720×480 25 fps: 720×576 4 Mbps (Avg.) 8 Mbps (Peak)
	Motion-JPEG	G.711 (uLaw, ALaw), PCM, ADPCM (G.726, MS IMA ADPCM)	30 fps: 720×480 25 fps: 720×576 60 fps: 320×240
MOV	MPEG4 (Advanced Simple Profile)	AAC, PCM	30 fps: 720×480 25 fps: 720×576 4 Mbps (Avg.) 8 Mbps (Peak)
	Motion-JPEG	G.711 (uLaw, ALaw), PCM, ADPCM (G.726, MS IMA ADPCM)	30 fps: 720×480 25 fps: 720×576 60 fps: 320×240
MP4	MPEG4 (Advanced Simple Profile)	AAC, PCM	30 fps: 720×480 25 fps: 720×576 4 Mbps (Avg.) 8 Mbps (Peak)
MOV MP4 M4V	H.264/AVC (Baseline Profile Level 1.3)	AAC, PCM	30 fps: 720×480 25 fps: 720×576 2.5 Mbps (Avg.) 3 Mbps (Peak)

**Note:**

- ❑ *The maximum supportable video file size is 2 GB.*
- ❑ *Some data may not be played even if the data is supported by the viewer.*

## Displaying photos or videos

When you want to view or edit photos or videos using the viewer, place the data in **My Photos** or **My Videos** respectively. To copy the data, see "Copying/Moving files or folders" on page 56.

1. Select **Backup Files**, **My Photos**, or **My Videos**, in the Home screen using the **Up** or **Down** key, then press the **Right** key.



**Note:**

Press the **Right** key to display the subfolders in the folder. You can easily navigate the folder structure when a subfolder is displayed on the right by selecting a folder with the **Up** or **Down** key and then pressing the **Right** key. Nothing is displayed on the right when the folder does not contain any subfolders.

2. Select the folder you want to display using the **Up** or **Down** key, then press the **OK** key.
3. Select a file to view using the **4-way ring**, then press the **OK** key to playback.





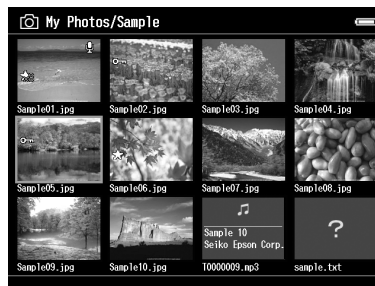

**Note:**

When viewing photos, pressing the **Right** key displays the next image and pressing the **Left** key displays the previous image.

## How to see the contents screen

The following illustrations identify the icons that appear on the screen.



	Indicates that the file or folder is locked. For details, see "Protecting files or folders" on page 57.
	Indicates unsupported data, such as a document.*
	Indicates that the file is set with the rating information.
	Indicates that a Sound Memo has been attached to an image from a digital camera.
	Indicates the file is in music format.
PV	Indicates that the folder is set as a private folder.
	Indicates that the folder is set as the screen saver.

\*You can set whether unsupported files are displayed or not. The factory setting is Hide. For details, see "Changing the Viewer Settings" on page 83.

**Note:**

- Thumbnails of the video files which have not been played back, or have not been played back completely are displayed with **NEW (N)** or **PAUSE (PA)** respectively.*
- Files names that contain characters not supported by the viewer may be displayed as "?", and may not be accessible.*

## Switching the screen

There are three kinds of screen to display files and folders. You can switch the following screen by pressing the **Display** key.

### Thumbnails screen

Files or folders appear in 12 divided thumbnails.

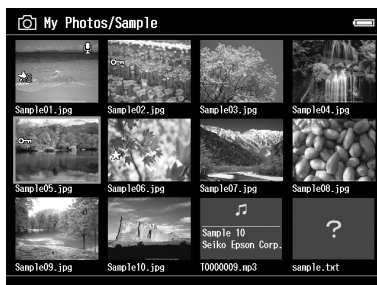

### Mini-Thumbnails screen

Files or folders appear in 64 divided thumbnails.

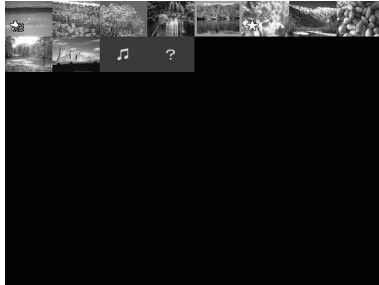

### Details screen

The modify date and file size are displayed.



### Switching the view mode

You can switch between two file display methods. As with the folder display method for computer data and for digital cameras, this method does not display all of the data. Switch the display method by following the procedure below.

1. Press the **Menu** key to display the pop up menu, select **Settings** using the **Up** or **Down** key, then press the **OK** key.
2. Select **Folder View** or **DSC View** using the **Up** or **Down** key, then press the **OK** key.

### Displaying information

When viewing a photo or video in full screen, press the **Display** key to display its information.

## Photo

For a photo file, no information is displayed first. You can switch to the file information (as below) by pressing **Display** key.



File information (general)



File information (detail)



Over-under exposure preview

### Note:

- ❑ In the over-under exposure preview, about 6% on each end of the brightness range (low and high) throughout the image shows graduated tone reversal allowing you to check exposure level. The brightest 6% of the image shows 4 grades of black, and the darkest 6% of the image shows 4 grades of white.
- ❑ Pressing the **Display** key while the over-under exposure preview appears displays the image without any information. Press the **Display** key again to return to the previous display.
- ❑ Digital camera images taken in sRGB are displayed in sRGB, and the images taken in Adobe RGB are displayed in Adobe RGB. Images with unknown Exif information are displayed using the Color Space setting in Settings.



## Video

For a video file, the progress information is displayed first. You can switch to the file information (as below) by pressing the **Display** key again.



## Zooming a photo

When viewing images in full screen, you can use the zoom function. The following table describes how the keys work.

Key	Operation
- / +	Zoom out / Zoom in
Back	Zoom out of the photo and back to full screen.
4-way ring	Move around the zoomed photo.
OK	Display the navigation screen on the photo.
Wheel key	View the next or previous photo without changing the zoom setting.

## Rotating a photo

1. During full screen display, press the **Menu** key to display the pop up menu, select **Edit** using the **Up** or **Down** key, then press the **OK** key.
2. Select **Rotate** using the **Up** or **Down** key, then press the **OK** key.
3. Select **Right** to rotate the image 90° clockwise or **Left** to rotate the image 90° counterclockwise using the **Up** or **Down** key, then press the **OK** key.
4. Press the **Back** key to complete.

**Note:**

- ❑ Photos can be rotated automatically if they have automatic rotate information and the viewer setting is set to **Auto-Rotation ON**. For details, see "Changing the Viewer Settings" on page 83.
- ❑ You can display the other photos in the folder using the **Right** or **Left** key.

**Displaying photo enhance**

During full screen display, pressing the **Menu** key to display the pop up menu, then selecting **Enhanced Photo Display Mode** enters the photo enhance mode. In this mode, the viewer discriminates someone's face or shooting scene automatically, then displays a color-optimized image on the display. Pressing the **Back** key returns the normal image display.

**Playing back sound memo**

You can playback audio memos (WAV format) attached to image files by a digital camera. During full screen display, press the **Menu** key to display the pop up menu, and then select Playback Sound Memo.

**Note:**

*This may not support all digital camera audio memos.*

**Playing videos**

The following table describes how the keys work while playing videos.

Key	Operation
OK	Play/Pause
Back*	Stops the video and returns to the previous screen.
- /+	Adjusts the volume.

Key	Operation
Left/Right	Rewind/Fast-forward**

\*When you press the **Back** key to stop playback, the viewer remembers the resume point for the next time you start playback. The next time you start playback, playback starts from 3 seconds before the resume point. If you want to play back the video from the beginning, press the **Menu** key during playback, select **Play Settings** (if displayed), **Play from Beginning**, then press the **OK** key. This function cannot be used for a video with total playback time of 1 minute or less. (Resume does not work for some video files.)

\*\*Rewind and fast-forward speed becomes faster if you press the Left/Right key several times while rewinding/fast-forwarding. (Rewind/Fast-Forward does not work for some video files.)

**Note:**

You can set the video screen size by selecting **Play at Full Screen** or **Play at Original Size** from Play Settings in the pop up menu. Setting **Play at Full Screen** displays the image by adjusting the longest side to the LCD display without changing the aspect ratio.

---

## Editing Photos

While editing your photos, you can check the results on the screen and then save the photos. In addition to standard correction presets, the Manual setting allows you to apply each correction manually. For RAW images, you can select one or multiple images to process and then save as a JPEG file.

### Editing a photo

You can edit photos in JPEG format. You can automatically correct photos to suit the scene as well as manually adjust settings such as brightness and contrast.

1. On the Thumbnail screen, select the JPEG photo that you want to edit. Or, you can display the photo in full screen.
2. Press the **Menu** key to display the pop up menu, select **Edit** using the **Up** or **Down** key, then press the **OK** or **Right** key.
3. Select **Retouch** using the **Up** or **Down** key, then press the **OK** key.
4. You can make various settings on the photo editing screen. For details on the various settings, see "Creating Custom Print" on page 64.

## ***RAW processing***

You can process RAW images and then save them in JPEG format. You can make various adjustments when processing. When selecting multiple images, you can process all of the data using the same settings.

1. On the Thumbnail screen, select the RAW image that you want to edit. Or, you can display the RAW image in full screen.
2. Press the **Menu** key to display the pop up menu, select **Edit** using the **Up** or **Down** key, then press the **OK** or **Right** key.
3. On the thumbnail screen, select **Select Photo and Process** using the **Up** or **Down** key, then press the **OK** key.  
In full screen, select **Process This Photo** using the **Up** or **Down** key, then press the **OK** key. Go to step 5.
4. Use the **4-way ring** and the **★** key to enter check marks in the check boxes of files you want to process, then press the **OK** key.
5. When a message screen appears, check the contents, and then use the **4-way ring** and **OK** key to proceed.
6. You can make various settings on the processing settings screen. For details on the various settings, see "Creating Custom Print" on page 64.

---

## ***Managing Files and Folders***

### ***Displaying photos as a slide show***

You can display JPEG photos as a slide show.

1. Highlight a file or folder to display as a slide show.

2. Press the **Menu** key to display the pop up menu, select **Slide Show** using the **Up** or **Down** key, then press the **OK** key.

The slide show starts.

**Note:**

- The slide show effect, duration, and slide show music can be selected. Pressing the **Menu** key during the slide show enables you to set the slide show settings from the pop up menu. Alternatively, you can set the slide show settings from Settings. For details, see "Changing the Viewer Settings" on page 83.*
- When slide show music is set, you can turn the volume up or down by pressing the + or - key.*

## Setting folders as Private

When **Show Private Folders** is set, you can select and hide folders so that other people cannot view them.

**Note:**

- Even if folders are set as private folders on the viewer, you may still be able to view them on a computer, depending on the computer settings.*
  - When a private folder is copied to a CD-R/DVD-R, it is copied as a hidden attribute.*
1. Highlight a folder to set as a private folder.
  2. Press the **Menu** key to display the pop up menu, select **Settings** using the **Up** or **Down** key, then press the **OK** or **Right** key.
  3. Select **Show Private Folders** using the **Up** or **Down** key, then press the **OK** key.

**Note:**

*If the private folder to set are already displayed, go to step 6.*

4. Enter the 4-digit password number using the **4-way ring**, then press the **OK** key.
5. Press the **Menu** key to display the pop up menu, select **Settings** using the **Up** or **Down** key, then press the **OK** or **Right** key.
6. Select **Set/Unset as Private** using the **Up** or **Down** key, then press the **OK** key.

7. Use the **4-way ring** and the **★** key to enter check marks in the check boxes of folders to set as private folders, then press the **OK** key.



**Note:**

Pressing the **Menu** key in the thumbnails screen displays the pop up menu. You can select either **Select All** or **Deselect All**, then press the **OK** key, or select **Apply** from the pop up menu.

**Note:**

To hide the folder set as a private folder, select **Hide Private Folders** in step 3.

## Changing a file's or folder's name

1. Highlight a file or folder to change the name of.
2. Press the **Menu** key to display the pop up menu, select **Edit** using the **Up** or **Down** key, then press the **OK** or **Right** key.
3. Select **Rename** using the **Up** or **Down** key, then press the **OK** key.

- The on-screen keyboard appears. Select a letter using the **4-way ring**, then press the **OK** key to input the selected letter.



**Note:**

- The cursor can be moved forward/backward by pressing the + or - key.
  - To delete the last letter input, press the **Back** key.
  - To cancel the operation, select **Cancel** using the **4-way ring**, then press the **OK** key.
- After inputting the name, select **Done** using the **4-way ring**, then press the **OK** key to complete.

## **Deleting files or folders**

- Highlight a file or folder to delete.
- Press the **Menu** key to display the pop up menu, select **Delete** using the **Up** or **Down** key, then press the **OK** key.

- Use the **4-way ring** and the **★** key to enter check marks in the check boxes of files or folders to delete, then press the **OK** key to complete.



**Note:**

Pressing the **Menu** key in the thumbnails screen displays the pop up menu. You can select either **Select All** or **Deselect All**, then press the **OK** key, or select **Apply** from the pop up menu.

When you want to delete files in full screen, press the **Menu** key to display the pop up menu, then select **Delete** to enter the deletion mode. Select **Delete** using the **Up** or **Down** key and press the **OK** key to complete. Press the **Right** or **Left** key to move to other files to delete. Select **Cancel** and press the **OK** key, or press the **Back** key to cancel the mode.

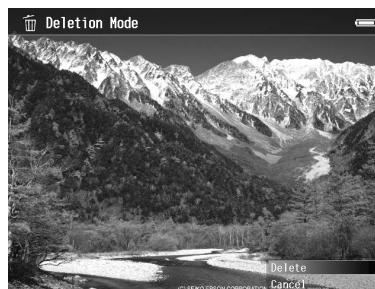

- After the confirmation dialog box appears, select **Yes** using the **Up** or **Down** key, then press the **OK** key to delete.

## **Copying/Moving files or folders**

- Highlight a file or folder to copy or move.
- Press the **Menu** key to display the pop up menu, select **Copy/Move** using the **Up** or **Down** key, then press the **OK** key.



3. Select **Select and Copy Files** or **Select and Move Files** using the **Up** or **Down** key, then press the **OK** key.

**Note:**

When selecting only one file to copy or move, select **Copy this File** or **Move this File**.

4. Use the **4-way ring** and the **★** key to enter check marks in the check boxes of files or folders to copy or move, then press the **OK** key to complete.



**Note:**

Pressing the **Menu** key in the thumbnails screen displays the pop up menu. You can select either **Select All** or **Deselect All**, then press the **OK** key, or select **Apply** from the pop up menu.

5. Select a folder to copy or move to using the **4-way ring**, then press the **OK** key.
6. When the confirmation dialog box appears after copying or moving is complete, press the **OK** key.

## Protecting files or folders

You can lock the selected file or folder. When a file or folder is locked, the  icon is displayed and it cannot be deleted or rotated.

1. Highlight a file or folder to lock.
2. Press the **Menu** key to display the pop up menu, select **Edit** using the **Up** or **Down** key, then press the **OK** or **Right** key.
3. Select **Lock/Unlock** using the **Up** or **Down** key, then press the **OK** key.

- Use the **4-way ring** and the **★** key to enter check marks in the check boxes of files or folders to lock, then press the **OK** key to complete. (Files or folders which have already been locked are displayed with check marks. Pressing the **OK** key removes the check mark and unlocks the file or folder.)



**Note:**

Pressing the **Menu** key in the thumbnails screen displays the pop up menu. You can select either **Select All** or **Deselect All**, then press the **OK** key, or select **Apply** from the pop up menu.

When you want to lock files in full screen, press the **Menu** key to display the pop up menu, then select **Edit, Lock/Unlock** to enter the lock mode. Select **Lock** or **Unlock** using the **Up** or **Down** key and press the **OK** key to complete. Press the **Right** or **Left** key to move to other files to lock. Select **Cancel** and press the **OK** key, or press the **Back** key to cancel the mode.

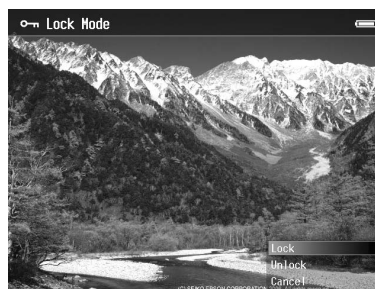

**Note:**

The lock on the file or folder remains in effect until you unlock it, even if you turn off the viewer.

## Setting Home screen wallpaper or folder icons

You can set your favorite image as wallpaper for the Home screen or a thumbnail of that folder.

- Select an image to set.

2. Press the **Menu** key to display the pop up menu, select **Wallpaper and Icon Settings** using the **Up** or **Down** key, then press the **OK** or **Right** key.
3. Select **Set as Folder Icon** using the **Up** or **Down** key, then press the **OK** key.

**Note:**

Select **Set as Wallpaper of HOME** to set the image as wallpaper for the Home screen. On the Home screen, press the **Menu** key to display the pop up menu. Then select **Reset wallpaper of HOME** to reset the Home screen wallpaper to the initial setting.

## Using ratings to filter your photos

When photos have ratings attached, you can filter them for display according to the number of ★ stars.

After selecting a photo file, press the ★ key. You can rate photos from ★1 to ★5.

**Note:**

- You can only rate JPEG and RAW image files.
- You cannot rate data stored on a USB device or memory card.
- When a photo file is rated ★5, pressing the ★ key deletes its rating.
- To edit a file that you rated with the viewer using Adobe Bridge, see the online Epson Link2 User's Guide.

When you want to filter photos, follow the procedure below.

1. Display the contents screen that you want to filter.
2. Press the **Menu** key to display the pop up menu, select **Rating Filter Display** using the **Up** or **Down** key, then press the **OK** or **Right** key.

3. Select the filter setting using the **Up** or **Down** key. Photos with that star rating or higher are displayed.

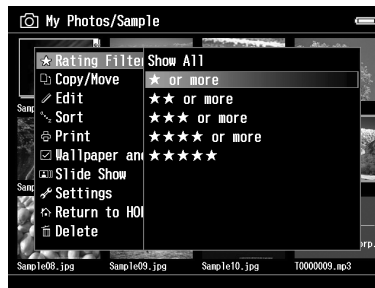

When you want to cancel filtering, follow the procedures in step 2, and then select **Show All**.

**Note:**

- Folders are always displayed after filtering.
- Files other than JPEG and RAW are not displayed after filtering.

## Setting the screen saver

1. Highlight a folder to set as the screen saver.
2. Press the **Menu** key to display the pop up menu, select **Set as Screen Saver** using the **Up** or **Down** key, then press the **OK** key.

**Note:**

- For using a screen saver, see "Changing the Viewer Settings" on page 83.
- To cancel the screen saver setting, select **Don't Use as Screen Saver** in step 2.
- The screen saver is activated only when the AC adapter is connected.

## Monitoring the Color of Images

You can display images from Adobe Photoshop products on the viewer and edit photos while confirming a faithful color representation.

To use the monitoring functions, install the software. For details, see "Installing the software" on page 26.

**Note:**

Some functions in Adobe applications are not supported. For details, see the documentation stored in the following location.

For Windows: Click Start, select All Programs (or Programs), EPSON, Viewer Tools, USB Display.

For Macintosh: Applications: Epson: Viewer Tools: USB Display

1. Use a supported Adobe Photoshop product to open the photo that you want to monitor on the viewer.
2. Open the USB connector's cover and connect the USB cable to the viewer. Then connect the other end of the USB cable to the computer.

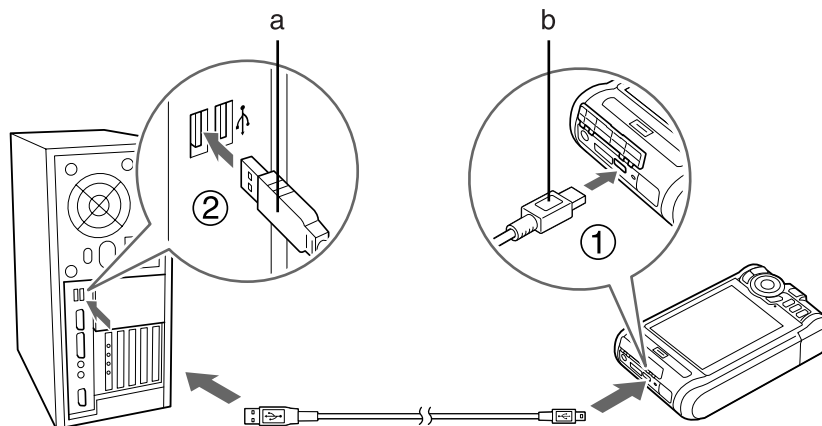

- a. USB (Standard-A)
- b. USB (Mini-B)

3. Select **USB Device** in the Home screen using the **Up** or **Down** key, then press the **OK** key.
4. Select **USB Display** using the **Up** or **Down** key, then press the **OK** key.
5. Monitoring begins automatically.
6. When you have finished, remove the USB cable connecting the viewer and the computer.

---

## About the Pop Up Menu

From the pop up menu displayed by pressing the **Menu** key, you can use the functions in the table below.

**For photo files**

Rating Filter Display	Sets the rating filter.
Enhanced Photo Display Mode	Displays photo images utilizing the features of the wide color gamut display.
Playback Sound Memo	Plays back sound memos.
Copy/Move	Copies/Moves files or folders.
Edit	Edits such as retouching, RAW processing, rotating photos, locking files, changing the name, and so on.
Sort	Sets the order of displaying in the list.
Print	Prints photo images.
Wallpaper and Icon Settings	Sets Wallpaper and icons of folders.
Set as Screen Saver	Sets Screen Saver files.
Slide Show	Starts Slide Show.
Settings	Sets LCD, beeps, showing private folders, setting as private, showing unsupported files, and so on.
Return to HOME	Returns to the HOME screen.
Delete	Deletes files or folders.

**For video files**

Copy/Move	Copies/Moves files or folders.
Edit	Edits such as locking files, changing the folder's name, and so on.
Sort	Sets the order of displaying in the list.
Play from Beginning	Plays back video files from the beginning.
Play Settings	Sets the display size of the video playback.
Set This Frame as Icon	Sets the currently displayed frame as an icon.
Display mode	Sets the most suitable display according to the movie content.
Settings	Sets LCD Brightness and whether or not to play a beep.

Return to HOME	Returns to the HOME screen.
Delete	Deletes files or folders.

**Note:**

*Different pop up menus will appear when you press the **Menu** key, depending on which screen you are viewing.*

## Chapter 6

### Creating Custom Print

---

You can print photos from this viewer without connecting it to a computer. Simply connect the viewer to a PictBridge compatible printer.

You can print out your projects by following the Print Wizard menu screen flows from editing photos to printing them out.

---

### Preparing to Print

#### Available types of paper

The viewer supports the following types of paper.

Premium Glossy Photo Paper
Premium Semigloss Photo Paper
Ultra Glossy Photo Paper
Glossy Photo Paper

**Note:**

*See the printer's manuals for details on the available kinds of paper and sizes.*

#### Registering a watermark

If you want to add a watermark to a photo, you need to register it first. You can register three items of photos or text.

**Note:**

*You can register the following types of images as watermarks.*

- PNG format images created in Adobe Photoshop.
- PNG format images containing partial transmission information.



- ❑ *Maximum data size: 10 MB*
- ❑ *Maximum image size: 720 x 480 pixels*
- ❑ *Not including animated files*

To register text, follow the procedure below.

1. On the Home screen, select **Settings**, using the **Up** or **Down** key, then press the **OK** key.
2. Select **Watermark Settings**, using the **Up** or **Down** key, then press the **OK** key.
3. Select **Create New Watermark** using the **Up** or **Down** key, then press the **OK** key.
4. Enter the text you want to use as a watermark. When you have finished entering the text, select **Done**, then press the **OK** key.
5. Select the text color, then press the **OK** key.
6. When the confirmation message appears, press the **OK** key.

To register images, follow the procedure below.

1. Create your image file (PNG format) on a computer.
2. Copy the image file to the viewer's My photos folder. To copy from the computer, see "Transferring to the Computer" on page 39.
3. Select an image file on the viewer, then press the **OK** key.

To remove registered watermarks, repeat steps 1 and 2 of the above procedure for registering text, and then select **Remove this Watermark** in step 3.

---

## ***Using the Print Wizard Menu***

Print Wizard has six menus to suit different purposes. See the table in step 2 for details on each menu.

1. On the Home screen, select **Print Wizard** using the **Up** or **Down** key, then press the **OK** key.



**Note:**

*If an unprinted job is stored in the viewer, follow the instructions on the screen.*

2. Select the menu you want using the **Up** or **Down** key, then press the **OK** key.

Menu	Details
Create Custom Print	You can edit photos and print them out. See "Creating Custom Print" on page 66.
Crop and Print	You can crop photos, lay them out on paper, and then print.
Edit Layout and Print	You can lay photos out on paper and then print.
Make Copies of Custom Print	You can make additional prints of your photo projects. See "Making Copies of Custom Print" on page 74.
Print Original Photo	You can print out the original photo. See "Printing Original Photo" on page 74.
Print Contact Sheet	You can print out a contact sheet displaying thumbnail images of your photos. See "Printing Contact Sheet" on page 75.

## Creating Custom Print

### Selecting a photo

1. Select **Create Custom Print** from the Print Wizard menu. For details, see "Using the Print Wizard Menu" on page 65
2. Use the **4-way ring** and the **OK** key to display photos in subfolders.

3. Use the **4-way ring** to select the photo you want to edit, then press the **OK** key. You can select JPEG or RAW data.

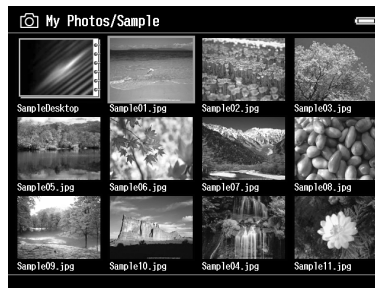

4. When a message screen appears, check the contents, and then use the **4-way ring** and **OK** key to proceed.

## ***Retouching a photo***

In Retouch Settings, you can select existing settings and automatically retouch photos. Or, you can make settings manually and then save them.

1. Select the current retouch settings or **Manual Settings** using the **Up** or **Down** key, then press the **OK** key. Go to step 5 if you select the current retouch settings.

- If you select **Manual Settings**, choose the setting item you want to change on the Retouch Additions or RAW Additional Adjustments screen using the **Up** or **Down** key, then press the **OK** key.

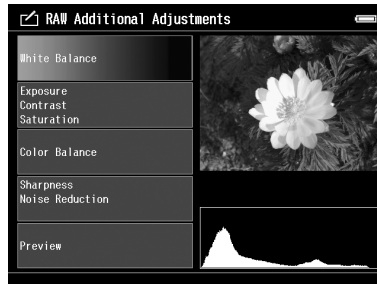

**Note:**

- The following setting items are available. Brightness, Contrast, Saturation, Color Balance, Monochrome Filter, Sharpness, Noise Reduction, White Balance, Exposure, and Contrast.*
  - Retouch items that you can set for JPEG and RAW data differ. Also, setting items for Color and Monochrome data differ.*
- Once you have set each retouch item, select **OK** on the screen, then press the **OK** key to return to the previous screen.
  - Select **Preview** using the **Up** or **Down** key, then press the **OK** key.
  - Your photo with retouches applied is displayed on the Retouch Preview or RAW Processing Preview screen.  
If you want to save the retouched photo, select **OK** or **Start Processing**, then press the **OK** key.  
If you want to make additional changes, select **Additional Adjustments** or **Custom Settings**, then repeat steps 2 to 4.
  - When a message screen appears, check the contents, and then use the **4-way ring** and **OK** key to proceed.

**Note:**

- The edited image is saved with the file name "Original file name\_Exx" in the following folder. My Photos > "PRINT" folder > "Date.xxx" folder*
- The RAW image is processed and saved in JPEG format.*

- ❑ *In some cases, you may not be able to display or process RAW data edited by other software applications.*

## Cropping a photo

You can make cropping settings for your images. You can crop using fixed ratios or custom settings.

1. On the Cropping setting screen, select the cropping method using the **Up** or **Down** key, then press the **OK** key.
2. When you select **Fixed Aspect**, select the aspect ratio using the **Up** or **Down** key.
3. Set the range to crop the image. The cropping area is indicated by a red line. Use the following procedure to move the red line.
 

For Fixed Aspect: Reduce or enlarge the frame using the **-/+** keys, and move the frame using the **4-way ring**. Press the **Display** key to rotate the frame.

For Free Aspect: Move the horizontal line using the **Up** or **Down** key and move the vertical line using the **Left** or **Right** key, and change the fixed point using the **★** key.

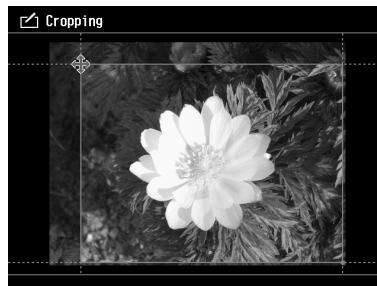

### Note:

- ❑ *You can fine tune the position with the wheel key. You can switch between Up/Down and Left/Right with the key that was operated previously.*
  - ❑ *You can perform the following by pressing the **Menu** key on this screen and selecting the menu.  
Display a grid, change the aspect ratio, adjust the horizontal angle, and reset settings*
4. When you have finished making the cropping settings, press the **OK** key.

5. Your photo with cropping applied is displayed on the Cropping Preview screen.  
If you want to save the cropped photo, select **OK**, then press the **OK** key.  
If you want to make additional changes, select **Additional Adjustments**, then repeat steps 3 to 4.

When saving the image, the Select Print Layout Size screen is displayed.

**Note:**

*The edited image is saved with the file name "Original file name\_Exx" in the following folder.  
My Photos > "PRINT" folder > "Date.xxx" folder.*

## Setting the layout

In Print Layout you can set the paper size, background color, water mark, and so on.

1. On the Select Print Layout Size screen, select the paper size using the **Up** or **Down** key, then press the **OK** key.
2. The image is laid out on the paper. Reduce or enlarge the image using the **-/+** keys, and move the image using the **4-way ring**. Press the **Display** key to rotate the image. If the width of the rotated image is greater than the length of the paper, the image is reduced to fit the length of the paper.

**Note:**

*You can fine tune the position with the wheel key. You can switch between Up/Down and Left/Right with the key that was operated previously.*

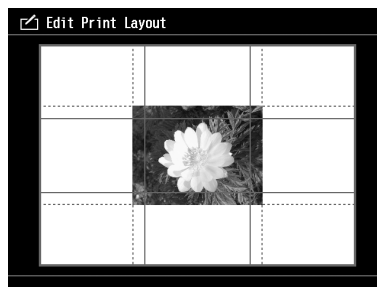

- Press the **Menu** key to make the background color, frame, and water mark settings.

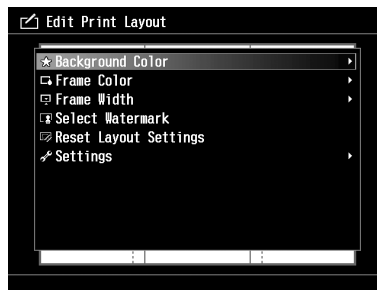

Menu	Details
Background Color	Select the background color.
Frame Color	Select the frame color.
Frame Width	Select the frame width.
Select Watermark	Select the Watermark.
Edit Watermark	You can reduce, enlarge, move, and rotate the water mark. Reduce/Enlarge: - /+ keys Move: 4-way ring Rotate: Display key
Reset Layout Settings	Reset all layout settings to their defaults.

- When you have finished making the settings, press the **OK** key.
- Your photo with the layout applied is displayed on the Print Layout Preview screen.  
If you want to save the laid out photo, select **OK**, then press the **OK** key.  
If you want to make additional changes, select **Additional Adjustments**, then repeat steps 2 to 3.

**Note:**

The edited image is saved with the file name "Original file name\_Exx" in the following folder.  
My Photos > "PRINT" folder > "Date.xxx" folder

- When saving the image, a confirmation screen appears asking whether or not you want to save it as a template. Select **Yes** and press the **OK** key to name the file and save it as a template.

**Note:**

*The on-screen keyboard appears and you can enter the template name. For details on the entry method, see steps 4 and 5 in "Changing a file's or folder's name" on page 54.*

## Printing photos

- Connect the USB cable and the AC adapter to the viewer.

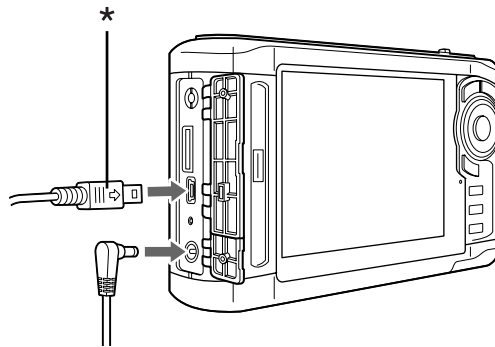

\*USB (Mini-B)



2. Connect the other end of the USB cable to the connector on the printer.

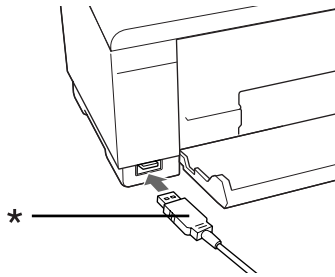

\*USB (Standard-A)

**Note:**

- See the printer's manual for the location of the cable connector on the printer.
  - Disconnect the USB cable from the viewer when not operating with a computer or printer.
  - When the viewer is connected to a printer, do not touch the Host-standard A connector interface. The viewer's operation may become unstable.
  - If a printer cannot be detected, the print job is saved.
3. On the confirmation screen, select **Yes**, then press the **OK** key.
  4. The printer is automatically detected, and the Print Settings screen appears. Make the necessary settings.

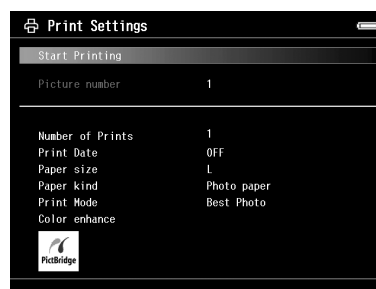

Setting	Detail
Number of Prints	Sets the number of prints.
Paper Size*	Sets the size of paper to use.

Setting	Detail
Paper Kind*	Sets the kind of paper to use.
Print Date**	Sets whether or not to print the date when the photo was taken.
Print Mode	Sets the print mode.
Color enhance***	When printing, the image data is automatically corrected and then printed.

\*Depending on the printer, you cannot select the paper as the setting is set to Auto.

\*\*If the photo does not include date information, the date of the file is printed.

\*\*\*Depending on the image and the printer, this function may not be available.

5. Press the **OK** key to start printing.

---

## ***Making Copies of Custom Print***

1. Select **Make Copies of Custom Print** from the Print Wizard menu. For details, see "Using the Print Wizard Menu" on page 65.
2. Select the project you want to print using the **4-way ring**.

**Note:**

*With this function you can select to print only projects you created using Print Wizard.*

3. Press the **OK** key to start printing. For details on print settings, see "Printing photos" on page 72.

---

## ***Printing Original Photo***

1. Select **Print Original Photo** from the Print Wizard menu. For details, see "Using the Print Wizard Menu" on page 65.
2. Open the subfolder using the **OK** key and the **4-way ring**.

3. Select the file you want to print using the **4-way ring**, and select the number of copies using the **-/+** key, then press the **OK** key.

**Note:**

*By pressing the **Menu** key, you can select all JPEG, RAW.*

4. Select the print layout.
5. Press the **OK** key to start printing. For details on print settings, see "Printing photos" on page 72.

---

## **Printing Contact Sheet**

1. Select **Print Contact Sheet** from the Print Wizard menu. For details, see "Using the Print Wizard Menu" on page 65.
2. Use the **4-way ring** to select the style of contact sheet, then press the **OK** key.
3. Open the subfolder using the **OK** key and the **4-way ring**.
4. Use the **4-way ring** and the **★** key to enter the check marks in the check boxes of files to print.

**Note:**

*By pressing the **Menu** key, you can select all JPEG, RAW.*

5. Press the **OK** key to start printing. For details on print settings, see "Printing photos" on page 72.

## Chapter 7

### Playing Music

You can listen to music on the viewer.

#### Transferring Audio Data from the Computer

Using the Epson Link2 software is recommended to transfer audio data from the computer to the viewer.

1. After installing the Epson Link2 software, connect the viewer to the computer. For details, see "Connecting the computer" on page 39.
2. Transfer files to the viewer.

**Note:**

- For details about the software, see the online *Epson Link2 User's Guide*.
- Only audio files transferred from a computer can be displayed in My Music. Within the viewer, you cannot copy or move audio files from/to My Music. If you want to play an audio file copied from memory cards, select it in Backup Files, then press the **OK** key. The file will be played according to the play mode setting.

#### Audio file formats supported by the viewer

File Format	Audio Codec	Details
M4A***	AAC (MPEG4)	Maximum bit rate: 320 kbps (48 kHz, 16 bit Stereo)
MP3*	MP3 (MPEG1/2/2.5 - Layer 3)	Maximum bit rate: 320 kbps (48 kHz, 16 bit Stereo)

\*Without copyright protection.

\*\*Non-Lossless-compliant format.

**Note:**

- The maximum supportable audio file size is 200 MB (up to 10,000 tracks).
- Some files may not be played back even if the files are supported by the viewer.

## Starting Playback

When playing back music, you can select the category or start resume play from the beginning of the previously played track. This function is useful to narrow down your music search.

### Selecting the category

1. Select **My Music** in the Home screen using the **Up** or **Down** key, then press the **OK** or **Right** key.



2. Select **Music List** using the **Up** or **Down** key, then press the **OK** or **Right** key.
3. Select a category to start playback using the **Up** or **Down** key, then press the **OK** or **Right** key.

You can narrow down your search by selecting the items in the following order using the **4-way ring**, if desired. Select **All** at the top of the list to include all items in the list.

Artist - Artist name - Album name - Track name
Album - Album name - Track name
Genre - Genre name - Artist name - Album name - Track name
All - Track name
Playlist* - Playlist name - Track name
Update Music List**

\*For details, see "Creating a Playlist on the Viewer" on page 80.

\*\*Select Update Music List to update audio data after transferring them from your computer.

4. Select the desired track using the **4-way ring**, then press the **OK** key to start playback.

## Resume play

1. Select **My Music** in the Home screen using the **Up** or **Down** key, then press the **OK** key.
2. Select **Resume** using the **Up** or **Down** key, then press the **OK** key.

You can start resume play from the beginning of the previously played track.

## Basic operations while playing music



Key	Operation
OK	Play/Pause
Back	Played From from My Photos/My Videos/Backup Files: Stops playback and returns to the previous screen. Played From from My Music: Returns to the music browse screen without stopping the music playback.
-/+	Adjusts the volume.
Left/Right	Skips back/forward.*
Display	Displays Codec, Bit Rate, and Sampling Rate.**

\*Pressing and holding the **Left/Right** key rewinds/fast-forwards the music.

\*\*The information contained in the ID3 tag (the name of file, track, artist, and so on) is displayed. The ID3 tag versions up to 2.4 are compatible, and up to 127 characters are displayable.

## Repeat and Shuffle Play

Press the **Menu** key to display the pop up menu in **My Music**, select **Play Mode** and set the following items using the **4-way ring** and the **OK** key.

Always select either **Shuffle** or **Normal Play Order** to set the playback order, and select the desired repeat play mode.

### **Repeat setting**

<b>Select</b>	<b>To play</b>
No Repeat	current category once
Repeat One Song	current track repeatedly
Repeat All	current category repeatedly

### **Playback order setting**

<b>Select</b>	<b>To play</b>
Shuffle	current category in random order
Normal Play Order	current category in normal order

---

## **Using the Features for Music**

### **Audio equalizer setting**

You can select the desired equalizer settings.

1. Press the **Menu** key to display the pop up menu in **My Music**.
2. Select **Audio Equalizer Setting**, then the desired setting, using the **Up** or **Down** key and the **OK** key.

Available equalizer settings are as follows: **Normal, Jazz, Classical, Rock, Pop, Live, Full Bass, Custom**.

3. If you select **Custom**, see "Customizing equalizer setting" on page 80. Otherwise, press the **OK** key to complete.

## Customizing equalizer setting

Selecting **Custom** in **Audio Equalizer Setting** allows you to create your own equalizer settings.

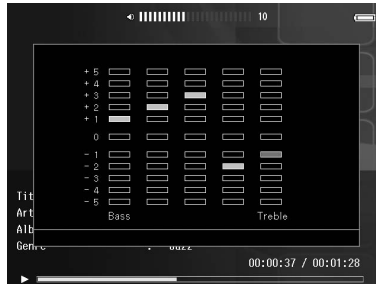

Adjust the level of each frequency using the **4-way ring**, then press the **OK** key to complete.

## Deleting album tracks from the viewer

1. Press the **Menu** key to display the pop up menu in a track name list in a category.
2. Select **Delete**, audio files to delete using the **4-way ring** and the **★** key, then press the **OK** key.
3. After the confirmation dialog box appears, select **Yes** using the **Up** or **Down** key, then press the **OK** key to complete.

---

## Creating a Playlist on the Viewer

Not only can you create a Playlist on the Epson Link2 software, you can also create them on the viewer.

1. Press the **Menu** key to display the pop up menu in a track name list in a category.
2. Select **Add to Playlist** using the **Up** or **Down** key, then press the **OK** key.
3. Select **Create New Playlist** using the **Up** or **Down** key, then press the **OK** key.



- The on-screen keyboard appears. Select a letter using the **4-way ring**, then press the **OK** key to input the selected letter.



**Note:**

To delete the last letter input, press the **Back** key. To cancel the operation, select **Cancel** using the **4-way ring**, then press the **OK** key.

- After inputting the name, select **Done** using the **4-way ring**, then press the **OK** key.
- Select tracks to include in the Playlist using the **4-way ring** and the **★** key.

**Note:**

If you want to select all the tracks to include in the Playlist, press the **Menu** key and select **Select All**.

- Press the **OK** key to complete.

## To add tracks to a created Playlist

Select the desired Playlist instead of **Create New Playlist** in step 3.

## To delete a Playlist/remove tracks from a Playlist

To delete a Playlist, select the desired Playlist, press the **Menu** key, then select **Delete this Playlist**.

You can remove tracks from a Playlist in the same way as you delete them from the viewer. If you select the audio files from a Playlist, they will be removed from the Playlist but not deleted from the viewer. For details, see "Deleting album tracks from the viewer" on page 80.

## ***To change track order of a created Playlist***

1. Open the track list of the Playlist to change the order of.
2. Select a track of which to change the order to move.
3. Press the **Menu** key to display the pop up menu, then select **Change Song Order**.
4. Move the track using the **Up** or **Down** key, then press the **OK** key to complete.

---

## ***About the Audio Pop Up Menu***

From the pop up menu displayed by pressing the **Menu** key, you can use the functions in the table below.

Add to Playlist	Adds audio files to Playlist/Creates new Playlist.
Audio Equalizer Setting	Sets the audio equalizer.
Delete	Deletes audio files.
Play Mode	Changes playback order/Sets repeat play.
Settings	Sets LCD, Key Beep.

**Note:**

*Different pop up menus will appear when you press the **Menu** key, depending on which screen you are viewing.*

## Chapter 8

### Customizing Settings

You can customize various settings for displaying and copying images, or change the sound setting to make the viewer more useful.

#### Changing the Viewer Settings

The settings described in the following table can be configured from Settings. To display the menu, select **Settings** in the Home screen, then press the **OK** key. For further setting operations, use the **4-way ring** and the **OK** key.

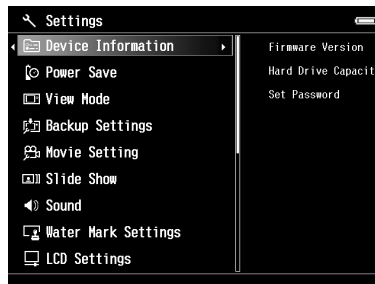

The following table shows details of each setting.

Device Info.	Firmware Version	Displays the firmware version.
	Hard Drive Capacity	CF/SD memory cards and the HDD used space is displayed with used disk space of Backup, My Photos, My Videos, and My Music.
	Set Password	Sets the password for private folders. The default password is "0000."

Power Save	Backlight Timer	Sets the time at which the LCD's backlight will turn off and the LCD will go blank if there are no operations. You can select the time from 1, 3, 5, 10, 15 minutes.
	Sleep Timer	Sets the time at which the viewer will enter sleep mode if there are no operations. To deactivate sleep mode, press any key. You can select the time from 1, 3, 5, 10, 15 minutes.
	Power Off Timer	Sets the time at which the power will be shut down automatically if there are no operations, to save the battery. You can select the time from 1, 3, 5, 10, 15 minutes.
	Screen Saver	Sets the time at which the screen saver will appear if there are no operations, to save the battery. You can select the time from 1, 3, 5, 10, 15 minutes.
View Mode	Video Out**	Select NTSC or PAL according to the TV system of the external display or TV to be connected to the viewer.
	Auto-Rotation	Sets whether or not to rotate the images automatically according to the EXIF information.
	Unsupported Files	Sets whether unsupported files are displayed or not.
	Color Space	Sets the color space, if the color space information of the image is unknown. Select sRGB or Adobe RGB to display images.
	RAW Image Display Settings	When enlarged RAW images are displayed, you can select from a thumbnail display and an image processing display only for RAW data from processing capable cameras.
Backup Settings	Backup Method	Set to perform a differential backup for data that was previously backed up from a memory card/USB device.
	Process After backup	Sets whether or not to delete the data on the memory card or the USB device after backing up onto the viewer is complete. You can also select the Verify backed up data option.
	Backup Completion Sound	Select None (no announcement), or one of the four preset sounds to announce the completion of data backup.
Movie Setting	Screen Size	Sets the screen size of a movie.
	Playback Mode	Set to play one video file or to play video files continuously.
	Movie Display Mode	Sets the mode, such as scenery or cinema, for video playback.

Slide Show	Effects*	Sets one of the five slide show effects. The slide show is executed with the selected effect.
	Duration*	Sets the duration to switch the images during a slide show. You can set the duration from 1 to 30 seconds.
	Slide Show Music*	Sets the slide show music which is played during the slide show. You can select None, one of three from the default playlist, or one from the user playlist.
	Clock*	Sets whether or not to display the clock during the slide show.
Sound	Guide Beep	Turns on/off the sound for an error in operation.
	Key Beep	Select ON or OFF to turn on or off the operation sound.
	Volume	Set the playback volume of audio and video.
Watermark Settings	-	Register or delete watermarks. For details, see "Registering a watermark" on page 64.
LCD Settings	LCD Brightness	Changes the brightness of the LCD. Adjust the brightness using the <b>Up</b> or <b>Down</b> key.
	LCD Custom setting	Sets the color for color temperature, gamma, gray, and other items.
Date and Time	Date and Time	Set the date, time and date format.
Language	Language	Choose one of ten languages. If you change the set language, you may not be able to access existing files or folders.

\*These settings are also effective for Screen Saver.

\*\* After changing the setting, reconnect the VIDEO cable.

## Chapter 9

### Viewing on a TV

#### Using A/V Out

The viewer has an A/V Out connector. You can play slide shows and videos on an external monitor by connecting the viewer to a monitor device, such as a TV, that has a video input connector.

Follow the instructions below to view photos or play videos on TV.

1. Set the Video Out setting on the viewer to the signal format of your TV.

**Note:**

*For details about the Video Out setting, see "Changing the Viewer Settings" on page 83.*

2. Connect a commercially available AV cable to the TV. Then connect the other end of the AV cable to the viewer.

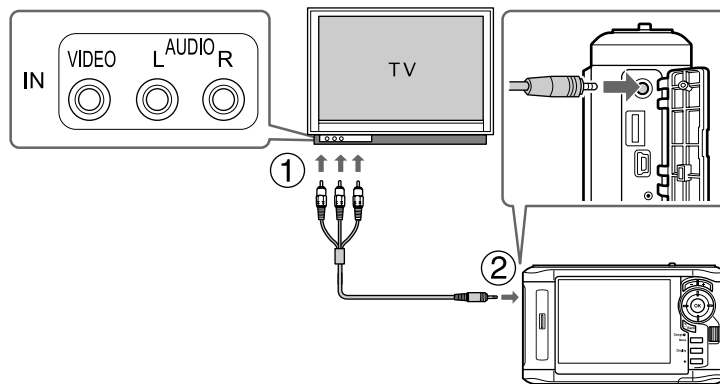

3. Set the TV display to video input from the viewer.

**Note:**

- The LCD turns off when you connect an AV cable to the viewer.*
- Some monitors cannot display full images and the top and bottom parts may be missing.*
- For information on available cables, contact our customer support.*

## Chapter 10

# Maintenance

---

## Cleaning the Viewer

---

To keep the viewer operating at its best, you should clean it thoroughly several times a year. Before you perform any maintenance on the viewer, be sure to read the <+ to Important Safety Instructions>, then follow these guidelines.

- Be sure to turn off before cleaning.
- Use a clean, dry cloth to keep the viewer free of dust.
- Do not use harsh or abrasive cleaners.
- If necessary, clean the battery contacts with a dry cloth.

## Preparing the Battery

---

### Installing the battery

1. Open the battery cover as shown below.

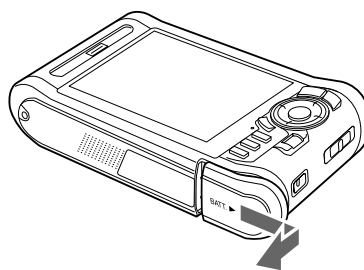

2. Insert the battery into the compartment in the direction of the arrow on the battery sticker.

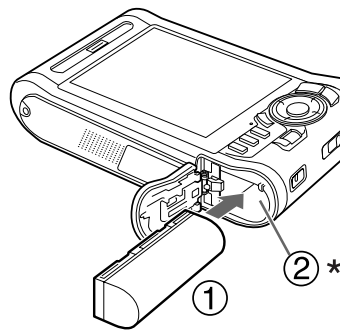

\*Insert the battery until it clicks and locks in place.

3. Close the battery cover and slide it to the left until it clicks.

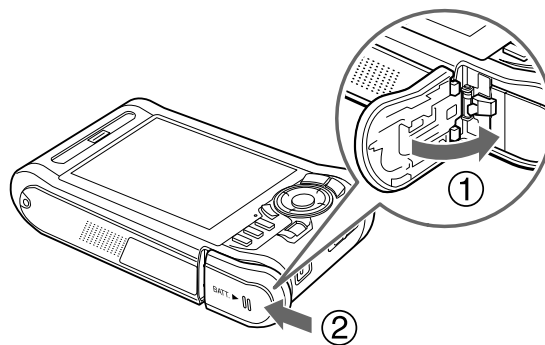

## Charging the battery

After installing the battery, connect the AC adapter. The installed battery will be automatically charged.

1. Make sure that the battery is installed.



**Caution:**

*Do not connect the AC adapter when the battery is not installed. Doing so may cause the viewer to be damaged.*



2. Connect the AC adapter as shown below, then plug the other end into a power outlet.

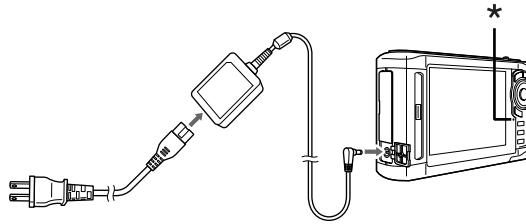

\*Charge lamp

The **Charge** lamp lights green during charging. When the battery is fully charged, the **Charge** lamp turns off. It takes about 3.5 hours to fully charge the battery when the power is off, more time if the viewer is in use.

**Note:**

- The viewer stops charging if the battery becomes hot when operating it during charging. In that case, it starts charging again when it cools down.*
- If the Charge lamp lights orange, see "Troubleshooting" on page 91.*

## Removing the battery

1. Make sure that the viewer is turned off.



**Caution:**

- Remove the AC adapter if connected.*
  - Never remove the battery while turned on. Doing so may cause data in the card or HDD to be lost or damaged.*
2. Open the battery cover.

3. Push the catch down.

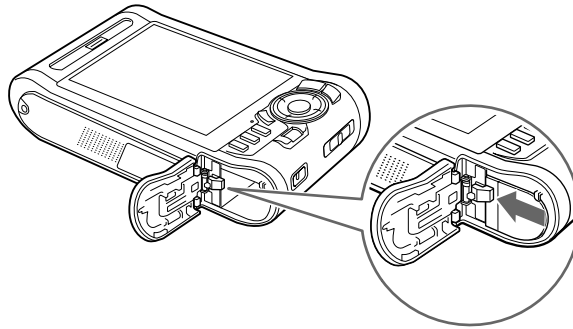

The battery is pushed out.

4. Pull out the battery, then close the battery cover.

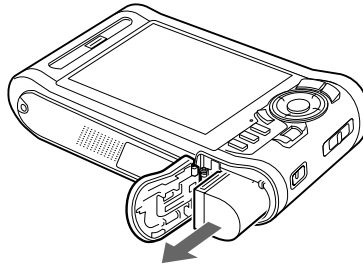

**Warning:**



*Do not carry loose batteries in your pocket.*

## Chapter 11

# Troubleshooting

## Error messages / Icons

When a problem occurs, an error message or icon usually appears in the LCD. Refer to the following section to solve the problem.

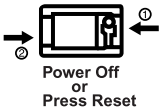
Error message/Icon	Description
Unable to access file.	Wait until the <b>Access</b> lamp turns off, then reinsert the memory card and try again. Check if there is no data damaged.
An error occurred during verification.	Some files failed to be copied. Check the data.
Cannot access the hard drive. There may be a problem with the hard drive, or it may not be formatted as FAT32.	Backup all the data to onto the computer, and test the format by following the procedure in "Formatting Data in the Viewer" on page 97. If this does not fix the problem, send the viewer to an authorized Epson service center. (The data on the viewer will be deleted.) Repairs will be chargeable and are not covered by Epson's warranties.
No response from the printer. Please check the printer.	Make sure of the following. <ul style="list-style-type: none"> <li>- Your printer is on.</li> <li>- The USB cable is connected correctly. (Printer: Standard-A. Viewer: Mini-B)</li> <li>- The cable supplied with the viewer is used.</li> <li>- Your printer is compatible with PictBridge.</li> </ul> Check your printer and printer's manual.
	Wait until the viewer cools down.
	The battery power is running out. Charge the battery. For details, see "Charging the battery" on page 88.
 Power Off or Press Reset	Press the reset button. See "Resetting the Viewer" on page 96 to find how to use the Reset button.

## ***Power supply problems***

### ***The power does not turn on***

Cause	What to do
The battery is set incorrectly.	Make sure that the battery is installed correctly. See "Charging the battery" on page 88.
The battery has run out.	See "Troubleshooting" on page 91 and charge the battery.

### ***The Charge lamp lights orange***

Cause	What to do
The battery is not inserted.	Insert the battery into the viewer.
The viewer becomes hot.	Turn off the power, disconnect the AC adapter, stop charging and wait more than 30 minutes, then connect the AC adapter again to restart charging. The <b>Charge</b> lamp still lights orange, contact our customer support.

## ***Viewing and playback problems***

### ***Cannot access data***

Cause	What to do
The name of a file or folder is not supported by the set language.	Rename the file or folder to access.

## ***The data is not displayed***

Cause	What to do
The photo, video, or audio file you selected is not supported.	See "Photo/Video file formats supported by the viewer" on page 43 or "Audio file formats supported by the viewer" on page 76 and make sure the data is supported. Also, check the codec of the data if you are trying to display a video file. You can convert and transfer video and audio files with the Epson Link2 software.
The data is broken.	Copy the data again.
The LCD Brightness setting is too dark.	See "Changing the Viewer Settings" on page 83 and make sure the LCD Brightness setting is set properly.
The video cable is connected to the viewer	Disconnect the video cable to display the LCD.
There is too much data to display on the screen at one time	Divide the data into multiple folders and switch to computer view. For details on switching the view mode, see "Switching the view mode" on page 47.

## ***The color space information cannot be recognized***

Cause	What to do
The color space information cannot be recognized with the viewer if you edit the image with image edit software.	Set the color space from Settings. For details, see "Changing the Viewer Settings" on page 83.

## ***The movie is not displayed clearly or stops abruptly***

Cause	What to do
The bit rate of the data is too high.	Check the bit rate. For details, see "Photo/Video file formats supported by the viewer" on page 43. You can convert and transfer video files with the Epson Link2 software.

## ***Sound breaks off when the video or audio is played***

Cause	What to do
The bit rate of the file is too high.	Check the bit rate. For details about video files, see "Photo/Video file formats supported by the viewer" on page 43. For details about audio files, see "Audio file formats supported by the viewer" on page 76. You can convert and transfer video and audio files with the Epson Link2 software.

## ***No sound comes out when a video is played***

Cause	What to do
The Audio Codec of the data is not supported.	Check the audio codec and the volume. For details about audio codec, see "Photo/Video file formats supported by the viewer" on page 43. You can convert and transfer video files with the Epson Link2 software.

## ***Operation problems***

### ***Cannot use the keys on the viewer***

Cause	What to do
The keys are deactivated because the power switch is set to <b>Hold</b> .	Check if the power switch is not set to <b>Hold</b> . If so, slide the power switch back to the middle.

### ***Cannot access the existing folders***

Cause	What to do
The set language does not support the folders' language.	Renaming the folder correctly enables you to access it. Alternatively, change the language setting. For details, see "Changing the Viewer Settings" on page 83.

## **Cannot copy**

Cause	What to do
The space available on the HDD is not sufficient to copy all of the data in the memory card, or the file may be damaged.	Delete unnecessary data in the HDD, reduce the size of data to copy from the memory card, or try to copy a different file.
The set language does not support the files' language.	Renaming the file correctly enables you to access it. Alternatively, change the language setting. For details, see "Changing the Viewer Settings" on page 83.
Copy cannot be started as the USB device connection cannot be recognized because the USB device has lost power.	Connect the AC adapter to the USB device. Alternatively, make sure that the viewer is connected the AC adapter correctly.

## **Cannot delete**

Cause	What to do
The file is locked. Alternatively, the file existing in the folder or subfolder is locked.	See "Protecting files or folders" on page 57 and unlock the file to delete it.

## **Cannot increase the hard drive capacity of the viewer even if deleting files**

Cause	What to do
Check if data was deleted without using the Epson Link2 software on the computer. Even if deleting data in the viewer on the computer, if the data has not been deleted completely, hard drive capacity of the viewer cannot be increased.	After connecting the viewer to the computer, delete all the data in "Recycle Bin" (Windows) or "Trash" (Macintosh).

## **Cannot set/unset as a private folder**

Cause	What to do
The password is wrong.	If you forget the password, enter "5555", "7777", then "3333" to reset the default password ("0000").

## Printing problems

### Cannot print

Cause	What to do
The printer is not supported.	See "Preparing to Print" on page 64 and make sure that your printer supports PictBridge.
The printer's power is off.	Turn on the printer.
The USB cable is not connected correctly.	See "Printing photos" on page 72 and reconnect the viewer to the printer.
The file is damaged.	Try to print a different file.
The file is a RAW file that cannot be processed.	Check the EPSON Web site for supported RAW files.

### The image color is different

Cause	What to do
The color tone of the LCD display differs from that of the printouts.	Adjust the brightness of the screen or the color temperature of the LCD display. For details, see "Changing the Viewer Settings" on page 83.

## Resetting the Viewer

When an error occurs and operations cannot be done, you can reset the viewer by pressing the **Reset** button with a thin object as shown below.

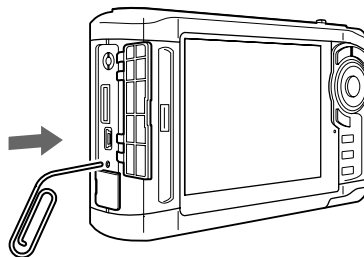

**Note:**  
Avoid using the fragile objects such as pencil.



---

## **Formatting Data in the Viewer**

You can delete all of the data from the viewer. Settings in the viewer itself are not deleted.

**Note:**

*Before formatting, be sure to backup important data to an external hard disk or memory device.*

1. Connect the AC adapter to the viewer.
2. Turn on the power while holding down the **OK** and **Menu** keys simultaneously.
3. Select **Yes** using the **Up** or **Down** key, then press the **OK** key.
4. Input the four digit password using the **Up**, **Down**, and **OK** keys, then press the **OK** key to finish.
5. When the format confirmation message appears, select **Yes** using the **Up** or **Down** key, then press the **OK** key.
6. When a message appears indicating that formatting is complete, turn off the power.

## Appendix A

# Customer Support

---

## Contacting Customer Support

---

### Before Contacting Epson

If your Epson product is not operating properly and you cannot solve the problem using the troubleshooting information in your product documentation, contact customer support services for assistance. If customer support for your area is not listed below, contact the dealer where you purchased your product.

Customer support will be able to help you much more quickly if you give them the following information:

- Product serial number  
(The serial number label is usually on the back of the product.)
- Product model
- Product software version  
(Click **About**, **Version Info**, or similar button in the product software.)
- Brand and model of your computer
- Your computer operating system name and version
- Names and versions of the software applications you normally use with your product

### Help for Users in North America

Epson provides the technical support services listed below.

#### Internet Support

Visit Epson's support website at <http://epson.com/support> and select your product for solutions to common problems. You can download drivers and documentation, get FAQs and troubleshooting advice, or e-mail Epson with your questions.

## ***Speak to a Support Representative***

Dial: (562)276-1300 (U.S.), or (905)709-9475 (Canada), 6am to 6pm, Pacific Time, Monday through Friday. Days and hours of support are subject to change without notice. Toll or long distance charges may apply.

Before you call Epson for support, please have the following information ready:

- Product name
- Product serial number
- Proof of purchase (such as a store receipt) and date of purchase
- Computer configuration
- Description of the problem

**Note:**

*For help using any other software on your system, see the documentation for that software for technical support information.*

## ***Purchase Supplies and Accessories***

You can purchase genuine Epson ink cartridges, ribbon cartridges, paper, and accessories from an Epson authorized reseller. To find the nearest reseller, call 800-GO-EPSON (800-463-7766). Or you can purchase online at <http://www.epsonstore.com> (U.S. sales) or <http://www.epson.ca> (Canadian sales).

## ***Help for Users in Europe***

Check your **Pan-European Warranty Document** for information on how to contact EPSON Customer support.

## ***Help for Users in Australia***

Epson Australia wishes to provide you with a high level of customer service. In addition to your product documentation, we provide the following sources for obtaining information:

## **Your Dealer**

Don't forget that your dealer can often help identify and resolve problems. The dealer should always be the first call for advice on problems; they can often solve problems quickly and easily as well as give advice on the next step to take.

## **Internet URL <http://www.epson.com.au>**

Access the Epson Australia World Wide Web pages. Worth taking your modem here for the occasional surf! The site provides a download area for drivers, Epson contact points, new product information and technical support (e-mail).

## **Epson Helpdesk**

Epson Helpdesk is provided as a final backup to make sure our clients have access to advice. Operators on the Helpdesk can aid you in installing, configuring and operating your Epson product. Our Pre-sales Helpdesk staff can provide literature on new Epson products and advise where the nearest dealer or service agent is located. Many types of queries are answered here.

The Helpdesk numbers are:

Phone: 1300 361 054

Fax: (02) 8899 3789

We encourage you to have all the relevant information on hand when you ring. The more information you prepare, the faster we can help solve the problem. This information includes your Epson product documentation, type of computer, operating system, application programs, and any information you feel is required.

## **Help for Users in Singapore**

Sources of information, support, and services available from Epson Singapore are:

### **World Wide Web (<http://www.epson.com.sg>)**

Information on product specifications, drivers for download, Frequently Asked Questions (FAQ), Sales Enquiries, and Technical Support via e-mail are available.

**Epson HelpDesk (Phone: (65) 6586 3111)**

Our HelpDesk team can help you with the following over the phone:

- Sales enquiries and product information
- Product usage questions or problems
- Enquiries on repair service and warranty

**Help for Users in Thailand**

Contacts for information, support, and services are:

**World Wide Web (<http://www.epson.co.th>)**

Information on product specifications, drivers for download, Frequently Asked Questions (FAQ), and e-mail are available.

**Epson Hotline (Phone: (66)2685-9899)**

Our Hotline team can help you with the following over the phone:

- Sales enquiries and product information
- Product usage questions or problems
- Enquiries on repair service and warranty

**Help for Users in Vietnam**

Contacts for information, support, and services are:

Epson Hotline (Phone): 84-8-823-9239

Service Center: 80 Truong Dinh Street, District 1, Hochiminh City Vietnam

**Help for Users in Indonesia**

Contacts for information, support, and services are:

**World Wide Web (<http://www.epson.co.id>)**

- ❑ Information on product specifications, drivers for download
- ❑ Frequently Asked Questions (FAQ), Sales Enquiries, questions through e-mail

**Epson Hotline**

- ❑ Sales enquiries and product information
- ❑ Technical support

Phone (62) 21-572 4350

Fax (62) 21-572 4357

**Epson Service Center**

Jakarta Mangga Dua Mall 3rd floor No 3A/B  
Jl. Arteri Mangga Dua,  
Jakarta  
Phone/Fax: (62) 21-62301104

Bandung Lippo Center 8th floor  
Jl. Gatot Subroto No.2  
Bandung  
Phone/Fax: (62) 22-7303766

Surabaya Hitech Mall lt IIB No. 12  
Jl. Kusuma Bangsa 116 – 118  
Surabaya  
Phone: (62) 31-5355035  
Fax: (62)31-5477837

Yogyakarta Hotel Natour Garuda  
Jl. Malioboro No. 60  
Yogyakarta  
Phone: (62) 274-565478

Medan Wisma HSBC 4th floor  
Jl. Diponegoro No. 11  
Medan  
Phone/Fax: (62) 61-4516173

Makassar                    MTC Karebosi Lt. Ill Kav. P7-8  
                                  JI. Ahmad Yani No.49  
                                  Makassar  
                                  Phone: (62)411-350147/411-350148

## ***Help for Users in Hong Kong***

To obtain technical support as well as other after-sales services, users are welcome to contact Epson Hong Kong Limited.

### ***Internet Home Page***

Epson Hong Kong has established a local home page in both Chinese and English on the Internet to provide users with the following information:

- Product information
- Answers to Frequently Asked Questions (FAQs)
- Latest versions of Epson product drivers

Users can access our World Wide Web home page at:

<http://www.epson.com.hk>

### ***Technical Support Hotline***

You can also contact our technical staff at the following telephone and fax numbers:

Phone:                    (852) 2827-8911

Fax:                        (852) 2827-4383

## ***Help for Users in Malaysia***

Contacts for information, support, and services are:

### ***World Wide Web (<http://www.epson.com.my>)***

- Information on product specifications, drivers for download

- ❑ Frequently Asked Questions (FAQ), Sales Enquiries, questions through e-mail

### ***Epson Trading (M) Sdn. Bhd.***

Head Office.

Phone: 603-56288288

Fax: 603-56288388/399

### ***Epson Helpdesk***

- ❑ Sales enquiries and product information (Infoline)

Phone: 603-56288222

- ❑ Enquiries on repair services & warranty, product usage and technical support (Techline)

Phone: 603-56288333

## ***Help for Users in India***

Contacts for information, support, and services are:

### ***World Wide Web (<http://www.epson.co.in>)***

Information on product specifications, drivers for download, and products enquiry are available.

### ***Epson India Head Office - Bangalore***

Phone: 080-30515000

Fax: 30515005

### ***Epson India Regional Offices:***

Location	Telephone number	Fax number
Mumbai	022-28261515 /16/17	022-28257287



Location	Telephone number	Fax number
Delhi	011-30615000	011-30615005
Chennai	044-30277500	044-30277575
Kolkata	033-22831589 / 90	033-22831591
Hyderabad	040-66331738/ 39	040-66328633
Cochin	0484-2357950	0484-2357950
Coimbatore	0422-2380002	NA
Pune	020-30286000 /30286001/30286002	020-30286000
Ahmedabad	079-26407176 / 77	079-26407347

### **Helpline**

For Service, Product info or to order a cartridge - 18004250011 (9AM - 9PM) - This is a Toll-free number.

For Service (CDMA & Mobile Users) - 3900 1600 (9AM - 6PM) Prefix local STD code

### **Help for Users in the Philippines**

To obtain technical support as well as other after sales services, users are welcome to contact the Epson Philippines Corporation at the telephone and fax numbers and e-mail address below:

Phone: (63) 2-813-6567

Fax: (63) 2-813-6545

E-mail: [epchelpdesk@epc.epson.com.ph](mailto:epchelpdesk@epc.epson.com.ph)

**World Wide Web** (<http://www.epson.com.ph>)

Information on product specifications, drivers for download, Frequently Asked Questions (FAQ), and E-mail Enquiries are available.

**Epson Helpdesk (Phone: (63) 2-813-6567)**

Our Hotline team can help you with the following over the phone:

- Sales enquiries and product information
- Product usage questions or problems
- Enquiries on repair service and warranty

## Appendix B

### Technical Specifications

#### Standards and Approvals

##### **P-6000 (Model: G971A)**

###### **U.S. model:**

EMC	FCC Part 15 Subpart B Class B CAN/CSA-CEI/IEC CISPR22 Class B
Safety	UL 60950-1 CSA C22.2 No.60950-1

###### **European model:**

EMC Directive 2004/108/EC	EN 55022 Class B EN 55024 EN 61000-3-2 (Use with AC adapter) EN 61000-3-3 (Use with AC adapter)
------------------------------	--

###### **Australian model:**

EMC	AS/NZS CISPR22 Class B
-----	------------------------

##### **AC adapter (Model: A351H)**

###### **U.S. model:**

Safety	UL60950-1 CSA C22.2 No.60950-1
EMC	CAN/CSA-CEI/IEC CISPR22 Class B

**European model:**

Low Voltage Directive 2006/95/EC EMC Directive 2004/108/EC	EN 60950-1 EN 55022 Class B EN 55024 EN 61000-3-2 EN 61000-3-3
---	--

**Australian model:**

Safety	AS/NZS 60950.1
EMC	AS/NZS CISPR22 Class B

**Battery (Model: D111A)****U.S. model:**

Safety	UL2054
--------	--------

**European model:**

EMC Directive 2004/108/EC	EN 55022 Class B EN 55024
------------------------------	------------------------------

**Australian model:**

EMC	AS/NZS CISPR22 Class B
-----	------------------------

---

**Specifications****General**

Display	LCD (Liquid Crystal Display) 4.0 inch 640 □ R-YG-B-EG □ 480 dots (Dot pitch 0.032 mm □ 4 □ 0.128 mm), (R: Red, YG: Yellow Green, B: Blue, EG: Emerald Green), Approx. 16,770,000 colors
---------	---

HDD	2.5" HDD (73.8 GB) FAT12/16/32 VFAT supported
Dimensions and weight	Height: 88.7 mm (3.5 inches)* Width: 150 mm (5.9 inches)* Depth: 33.1 mm (1.3 inches)* Weight: Approx. 428 g (0.94lb) (including the battery)
Temperature	Operating: 5 to 35°C** Non-operating: -20 to 60°C
Humidity (without condensation)	Operating: 30 to 80%** Non-operating: 10 to 80%
Altitude	Operating: 3000 m or less Non-operating: 12000 m or less
Memory card***	CompactFlash memory card (Type2 and 3.3 V, including MicroDrive), SD memory card, SD High-Capacity card, MultiMedia Card, MultiMedia Card Plus
Power sources	Lithium-ion battery (Model: D111A) AC adapter (Model: A351H)
Battery life (when fully charged)****	Approx. 3.5 hours when playing a slide show (in the default settings) Approx. 3 hours when playing video (MPEG4, 2 Mbps, using the headphones) Approx. 6 hours when playing audio (MP3, 128 kbps, using the headphones)

\*Dimensions do not include projections.

\*\*Charging is recognized as operating.

\*\*\* Commercially available adapters will be required to use other memory cards (miniSD, microSD, RS-MMC, Memory Stick Duo, Memory Stick PRO Duo, xD-Picture Card, and so on). Contact our customer support for details.

\*\*\*\*Times may vary depending on the memory card being used, the number of files, ambient temperature, and other factors.

## Electrical

Input voltage	5 V DC (AC adapter) 3.7 V DC (Lithium-Ion battery)
Rated current	Maximum 2.3 A
Power consumption	6.6 W (Using with the battery) 8.2 W (Using with the AC adapter)

## Interface

USB connector	Two USB 2.0 (Mass Storage Class) interface Host: 2.0 Full Speed and High Speed mode (Standard-A) Slave: 2.0 Full Speed and High Speed mode (Mini-B)
A/V Out connector	Quadruple mini pin jack (Ø 3.5 mm)
Headphones connector	3-pole mini pin jack (Ø 3.5 mm)
CF Card slot	One slot (Type2, 3.3 V) for CompactFlash memory card and MicroDrive
SD Card slot	One slot for SD memory card, SD High-Capacity card, MultiMedia Card, and MultiMedia Card Plus

## Battery

Type	Lithium-Ion battery
Model	D111A
Size (H □ W □ L)	22.45 mm □ 20.4 mm □ 71 mm
Ratings	3.7 V, 2600 mAh (Typ.)
Temperature	Storing: -20 to 40°C*

\*Keep the battery in a cool place when storing it for a long period.

## AC adapter

Model	A351H
Input	AC 100 - 240 V, 50 - 60 Hz, 0.3 A - 0.1 A
Output	DC 5.0 V, 2.3 A
Power consumption	Maximum 18 W

---

## About Optional Accessories

The following options are available for the viewer.

optional product	product code
Lithium-Ion battery (Model: D111A)	B32B81826* *

\*The asterisk ( \* ) is a substitute for the last digit, which varies by country.

## Index

- A**
- Audio equalizer setting.....79
- B**
- Backing up data
    - from the viewer onto the computer.....36, 39
  - Battery
    - charging.....88
    - installing.....87
    - removing.....89
- C**
- Changing a file's name or folder's name.....54
  - Cleaning the viewer.....87
  - Connecting to the computer.....39
  - Contacting Epson.....98
  - Copying data to Photos or Videos
    - from USB devices.....34, 37
- D**
- Deleting
    - audio files.....80
    - files or folders.....55, 56
  - Disconnecting from the computer.....41
- F**
- File format
    - audio.....76
  - Folder thumbnail.....58
- H**
- Help
    - Epson.....98
  - Holding the key operations.....24
  - Home screen.....24
- I**
- Important notice.....18
  - Information.....47
    - photo.....48
    - video.....49
- K**
- Key
    - while playing music.....78
    - while playing videos.....50
- M**
- Main features.....18
  - Memory card
    - inserting.....30
    - removing.....30
  - Music playback.....77
- O**
- Optional accessories.....111
- P**
- Parts.....19
    - back.....20
    - front.....19
    - LCD and control panel.....21
  - Playlist
    - adding tracks.....81
    - changing track order.....82
    - creating.....80
    - deleting/removing tracks.....81
  - Play mode.....78
  - Pop up menu
    - photo files.....62
    - video files.....62
  - Printer.....64
    - available types of paper.....64



Private folders.....	53	printing problems.....	96
Problems, solving		viewing and playback problems.....	92
contacting Epson.....	98	Turning the power off.....	23
Protecting files or folders.....	57	Turning the power on.....	22
 <b>R</b>		 <b>V</b>	
Rate.....	59	Video output.....	86
Resetting the viewer.....	96		
 <b>S</b>			
Safety instructions.....	10		
Safety requirements.....	16		
Screen			
icons.....	44		
switching.....	46		
Screen saver.....	60		
Service.....	98		
Setting			
backlight timer.....	84		
date and time.....	85		
language.....	85		
power off timer.....	84		
screen saver.....	84		
sleep timer.....	84		
slide show clock.....	85		
slide show duration.....	85		
slide show effects.....	85		
slide show music.....	85		
volume.....	85		
Slide show.....	52		
Software			
installing.....	26		
launching.....	40		
Specifications.....	108		
Standards and approvals.....	107		
 <b>T</b>			
Transferring audio data.....	76		
Troubleshooting			
error messages/icons.....	91		
operation problems.....	94		
power supply problems.....	92		